



2018 TECH CATALOG

BUTTERFLY TABLE TENNIS EQUIPMENT

RUBBER / BLADES / APPAREL / TABLES / ROBOTS / BALLS



SRIVER



SPIN ART



ROZENA



TRYCE Speed



TENERGY 64



FEINT LONG II



TRYCE HIGH SPEED



TENERGY 05





RUBBER

TENERGY 05

Excellent for Imparting Spin on the Ball

HIGH TENSION

Spring Sponge



TENERGY 05 FX

Topspin and Control

HIGH TENSION

Spring Sponge



TENERGY 25

Excellent for Attacking and Controlled Play near the Table

HIGH TENSION

Spring Sponge

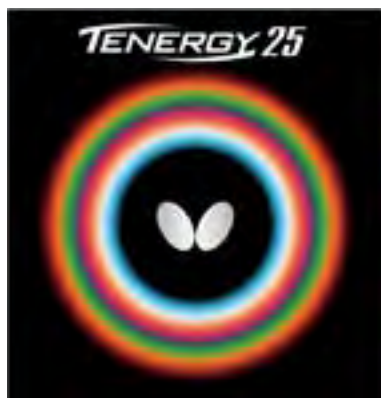

TENERGY 25 FX

For Power and Control

HIGH TENSION

Spring Sponge



TENERGY 64

The Speed Effect

HIGH TENSION

Spring Sponge



TENERGY 64 FX

For Speed and Control

HIGH TENSION

Spring Sponge



TENERGY 80

Ideal Balance Between Spin and Speed

HIGH TENSION

Spring Sponge



TENERGY 80 FX

Ideal Balance Between Spin and Speed with Control

HIGH TENSION

Spring Sponge



ROZENA

New Product

High Performance Rubber
Rozena Developed in the
Pursuit of 'Tolerance'



HIGH TENSION

Spring Sponge



MICROLAYER

A NEW ACHIEVEMENT OF THE BUTTERFLY RESEARCH

The base of the top sheet is very thin, visible to the naked eye. The rubber compresses and the surface is "depressed" by the ball on impact; thus enabling a high degree of rotation to be imparted on the ball.

BRYCE HIGHSPEED

High-Performance
Rubber with Unique
Technology "Micro Layer"

MICROLAYER

HIGH TENSION



BRYCE SPEED

High Tension Rubber
Which Goes Beyond
Bryce

HIGH TENSION

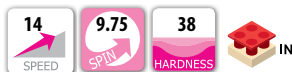

BRYCE SPEED FX

Bryce Speed with
Higher Control

HIGH TENSION



BRYCE

The World's First High
Tension Rubber

HIGH TENSION



BRYCE FX

The High Tension Rubber
with a Softer Touch

HIGH TENSION

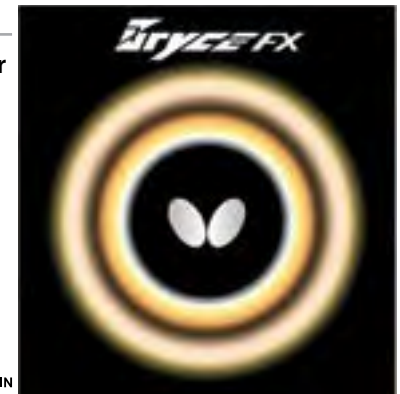



Spring Sponge

THE SENSE OF "CATCHING" BALLS

Like a spring coil, the Spring Sponge absorbs the incoming energy of the ball and releases it as additional power for the player's own shot. Rubbers with Spring Sponge technology enable shots with high amounts of spin.



HIGH TENSION

TOP ATHLETES RELY ON ITS TECHNOLOGY

High Tension technology enhances the reaction of the playing surface by adding tension to the rubber molecule itself; this is made possible by applying special substances to rubber materials.

SPIN ART

High Friction High Tension Rubber with Strengthened Bounce

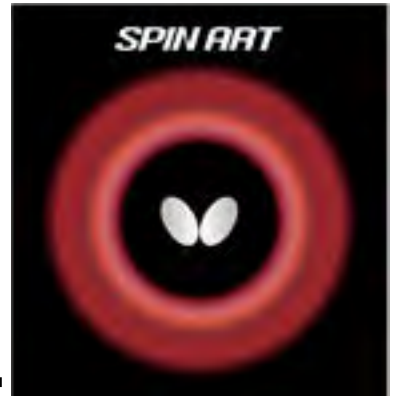

HIGH TENSION

 Spring Sponge



ROUNDELL

Fulfill Your Potential



HIGH TENSION



ROUNDELL HARD

Speed, Spin and Control



HIGH TENSION



ROUNDELL SOFT

Speed and Spin



HIGH TENSION



SRIVER

PASSION OF INFINITE POSSIBILITY

SRIVER

The World's Longtime Best Seller

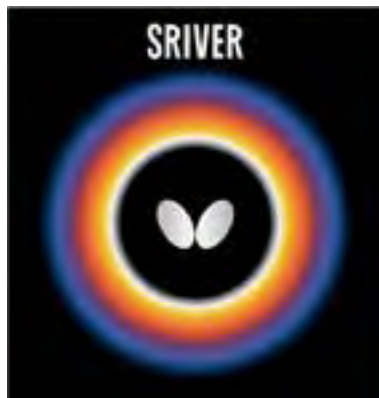

SRIVER EL

SRIVER with Instant Power and Control

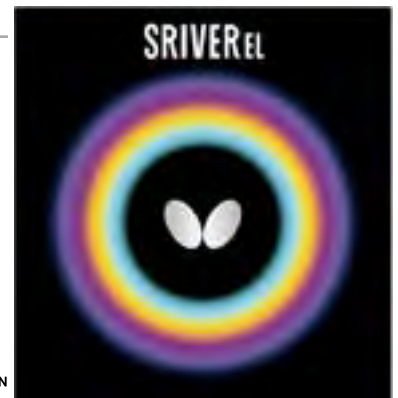

SRIVER FX

SRIVER with Outstanding Stability



FLEXTRA

Easy-to-Handle Rubber for Developing Players

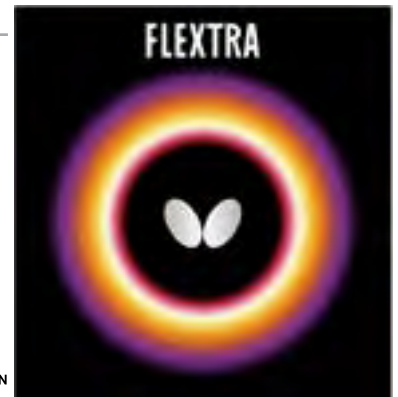

SAPPHIRA

Easy-to-Handle Rubber for Attack

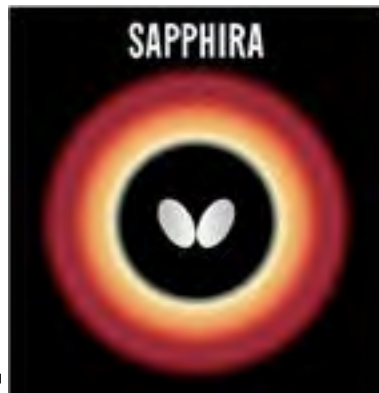

TACKIFIRE DRIVE

Well-Balanced Friction Rubber



TACKINESS CHOP

Friction Rubber for Defensive Players

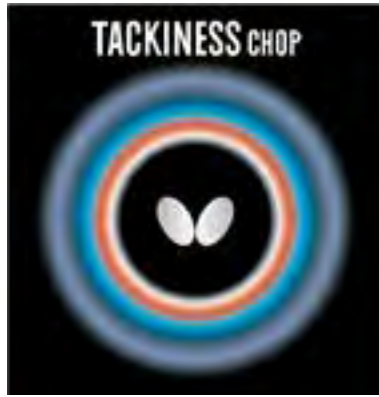

TACKINESS CHOP II

Friction Rubber Good at Spinning



TACKINESS DRIVE

Friction Rubber for Wide Range of Players



SUPER ANTI

Anti Rubber to Toss Opponents



CHALLENGER ATTACK

Pimples-Out Rubber for Quick Attack



SPEEDY P.O.

Well-Balanced Pimples-Out with an Ideal Parabola

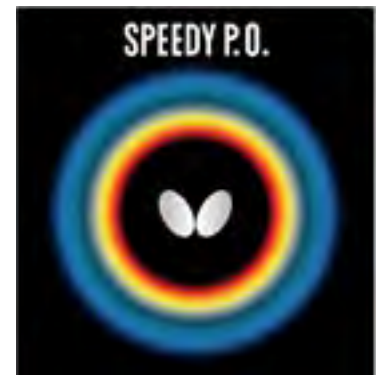

FLARESTORM II

High Tension Pimples-Out with High Reaction



HIGH TENSION



RAYSTORM

High Tension Pimples-Out with High Elasticity and Spin

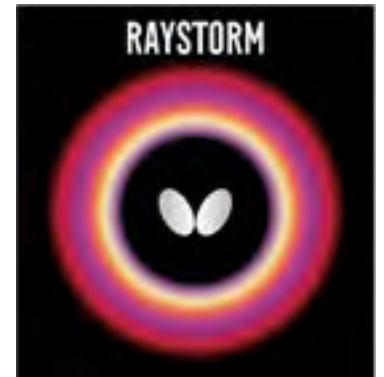

HIGH TENSION



IMPARTIAL XB

In Pursuit Of The Balance Between Attacking And Defense

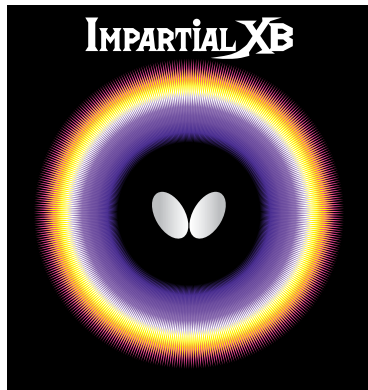

HIGH TENSION



IMPARTIAL XS

Enables Powerful Top-spin Plays

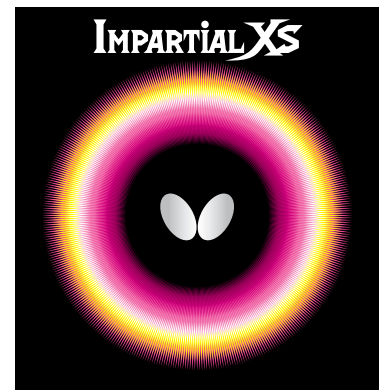

HIGH TENSION



ORTHODOX DX

Pimples-out without Sponge with Usability

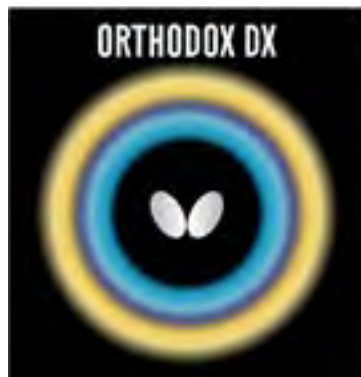

FEINT AG

High Tension Long Pimpled Rubber for Attacking Players



FEINT LONG II FEINT LONG II OX

Long Pimpled Rubber for Steady Plays

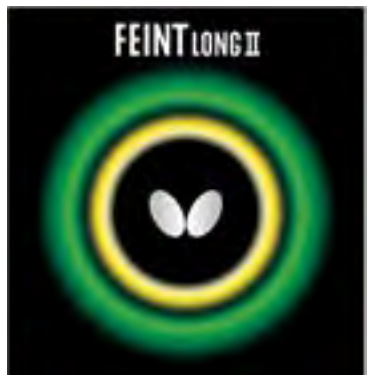

FEINT LONG III

Long Pimpled Rubber with Amazing Variety of Spins

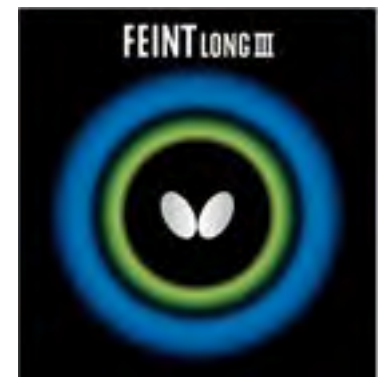

FEINT OX

Well-Balanced Long Pimpled without Sponge



FEINT SOFT

Well-Balanced Long Pimpled Rubber



Rubber Matrix



● = Pips-in and Anti Rubber ● = Short Pips-out Rubber ● = Long Pimples Rubber

Isotype for Butterfly Rubber

Sponge

MAX THICKNESS	3.8-4.0mm (Including Rubber Sheet)	2.1 THICKNESS	1.9-2.2mm
1.9 THICKNESS	1.7-1.9mm	1.7 THICKNESS	1.5-1.7mm
1.3 THICKNESS	1.1-1.3mm	1.1 THICKNESS	0.8-1.1mm
		0.5 THICKNESS	0.4-0.7mm

Speed

10 SPEED The measure for speed of SRIVER is 10.

Spin

10 SPIN The measure of spin for TACKINESS CHOP is 10.

Hardness

38 HARDNESS It refers to the sponge; the higher the number, the harder the sponge.

- The numbers are based on the research conducted by the Butterfly Research and Development Department in January, 2017.

Rubber Categories

Pimples-in Rubber



● Pimples-in Rubber

A rubber with a large contact area for the ball, which makes it easy to impart spin; there are two types, highly elastic with high reaction and moderate for control.

● High Tension Pimples-in Rubber

A rubber with very high elasticity and friction; it is created by impacting tension into the rubber molecule.

● High Friction Pimples-in Rubber

A rubber which imparts spin on the ball with ease as a result of the tackiness of the surface.

● High Friction High Tension Pimples-in Rubber

A rubber with very high elasticity and friction created by impacting tension into the rubber molecule as well as enabling spin to be imparted on the ball owing to the tackiness of the surface.

Pimples-out Rubber



● Pimples-out Rubber

A rubber with a small contact area on the ball, which means it is less affected by the opponent's spin as the ball does not stay on the rubber for long.

● High Tension Pimples-out Rubber

A pimples-out rubber with very high elasticity created by impacting tension into the rubber molecule.



● Pimples-out Rubber (without Sponge)

A rubber without sponge; it is light weight and has low elasticity.

Long Pimples Rubber



● Long Pimples Rubber

A long pimples rubber with unexpected variety of rotations as the pimples easily transform on contact.

● High Tension Long Pimples Rubber

A long pimples rubber which combines variation and elasticity; created by impacting tension into the rubber molecule.



● Long Pimples Rubber (without Sponge)

A long pimples rubber without sponge; it is light weight and has low elasticity.

Anti-Spin Rubber



● Anti-Spin Rubber

A rubber with less friction; it is less affected by the amount of spin applied by the opponent.

BUTTERFLY RUBBER SPECIFICATION CHART

RUBBER	SURFACE	CATEGORY	SPEED	SPIN	HARDNESS	SPONGE THICKNESS (MM)
Bryce	Inverted	High Tension Pimples-in Rubber	12.00	9.50	35	1.9, 2.1
Bryce FX	Inverted	High Tension Pimples-in Rubber	12.00	9.50	33	2.1
Bryce High Speed	Inverted	High Tension Pimples-in Rubber	14.50	10.30	35	1.9, 2.1
Bryce Speed	Inverted	High Tension Pimples-in Rubber	14.00	9.75	38	2.1
Bryce Speed FX	Inverted	High Tension Pimples-in Rubber	14.00	9.75	32	2.1
Challenger Attack	Pips-Out	Pimples-out Rubber	9.50	6.50	35	1.5, 1.9, 2.1
Feint AG	Pips-Out	High Tension Long Pimpled Rubber	7.00	4.00	28	1.3, 1.7
Feint Long II	Pips-Out	Long Pimpled Rubber	6.25	3.25	38	0.5, 1.1, 1.3
Feint Long II OX	Pips-Out	Long Pimpled Rubber (without Sponge)	6.25	3.25	n/a	OX
Feint Long III	Pips-Out	Long Pimpled Rubber	6.00	4.00	25	0.5, 1.1, 1.3
Feint OX	Pips-Out	Long Pimpled Rubber (without Sponge)	4.50	3.50	n/a	OX
Feint Soft	Pips-Out	Long Pimpled Rubber	5.50	3.50	25	1.5
Flarestorm II	Pips-Out	High Tension Pimples-out Rubber	11.70	6.70	32	1.9, 2.1
Flextra	Inverted	Pimples-in Rubber	8.25	8.75	32	1.9
Impartial XB	Pips-Out	High Tension Pimples-out Rubber	11.90	6.70	30	1.7, 1.9, 2.1, MAX
Impartial XS	Pips-Out	High Tension Pimples-out Rubber	12.20	7.90	30	1.7, 1.9, 2.1, MAX
Orthodox DX	Pips-Out	Pimples-out Rubber (without Sponge)	6.00	4.25	n/a	OX
Raystorm	Pips-Out	High Tension Pimples-out Rubber	9.75	7.00	34	1.9, 2.1
Roundell	Inverted	High Tension Pimples-in Rubber	12.80	10.20	35	1.9, 2.1
Roundell Hard	Inverted	High Tension Pimples-in Rubber	12.80	10.20	40	2.1
Roundell Soft	Inverted	High Tension Pimples-in Rubber	12.80	10.20	32	2.1
Rozena	Inverted	High Tension Pimples-In Rubber	13.00	10.80	35	1.7, 1.9, 2.1
Sapphira	Inverted	Pimples-in Rubber	8.75	8.50	35	1.9
Speedy PO	Pips-Out	Pimples-out Rubber	10.00	6.00	35	1.9
Spin Art	Inverted	High Friction High Tension Pimples-in Rubber	11.90	11.50	48	1.9, 2.1
Sriver	Inverted	Pimples-in Rubber	10.00	8.00	38	1.5, 1.7, 1.9, 2.1, MAX
Sriver EL	Inverted	Pimples-in Rubber	10.00	8.00	35	1.9, 2.1
Sriver FX	Inverted	Pimples-in Rubber	10.00	8.00	33	1.9, 2.1
Super Anti	Inverted	Anti-Spin Rubber	4.00	3.00	25	1.9
Tackifire Drive	Inverted	High Friction Pimples-in Rubber	9.00	9.25	38	2.1
Tackiness Chop	Inverted	High Friction Pimples-in Rubber	6.50	10.00	32	1.5, 1.7, 1.9
Tackiness Chop II	Inverted	High Friction Pimples-in Rubber	7.50	10.00	41	1.5, 1.9
Tackiness Drive	Inverted	High Friction Pimples-in Rubber	8.50	9.00	38	1.9
Tenergy 05	Inverted	High Tension Pimples-in Rubber	13.00	11.50	36	1.7, 1.9, 2.1
Tenergy 05 FX	Inverted	High Tension Pimples-in Rubber	13.00	11.50	32	1.9, 2.1
Tenergy 25	Inverted	High Tension Pimples-in Rubber	13.25	11.00	36	1.9, 2.1
Tenergy 25 FX	Inverted	High Tension Pimples-in Rubber	13.25	11.00	32	1.9, 2.1
Tenergy 64	Inverted	High Tension Pimples-in Rubber	13.50	10.50	36	1.9, 2.1
Tenergy 64 FX	Inverted	High Tension Pimples-in Rubber	13.50	10.50	32	1.9, 2.1
Tenergy 80	Inverted	High Tension Pimples-in Rubber	13.25	11.25	36	1.9, 2.1
Tenergy 80-FX	Inverted	High Tension Pimples-in Rubber	13.25	11.25	32	1.9, 2.1

BUTTERFLY

SPECIAL MATERIAL





Super ZL-Carbon has 1.8 times as much densely woven Carbon-Fibers and ZL-Fibers in mass, as the existing ZL-Carbon by using special technology. The remarkable reaction and control provided by the expanded high-reaction area has taken the blade to the next stage.



Arylate-CARBON

Arylate-Carbon is a special material created with a woven combination of Arylate and Carbon. Blades using Arylate-Carbon have power, speed and control.



Arylate-CARBON

ZL FIBER

ZL-Fiber has a detailed molecular configuration that is strong and elastic. Its ratio is 10 percent lower than Carbon fiber, thus making the blade both light and with a high performance level.



ZL FIBER

ZL CARBON

ZL-Carbon is a woven combination of Carbon fiber and ZL fiber. Carbon fiber has a high reaction level and ZL fiber provides strength, elasticity and lightness. ZL-Carbon, the super fiber, gives the blade a high level of performance.



ZL CARBON



Butterfly only uses Hinoki wood cut from trees over a hundred years old which grew on the northern side of the inclined plane of the Kiso Mountains, an area where trees are subject to less harmful rays from the sun. The wood grain is of vital importance for the Hinoki blade, a dense grain produces a good bounce.

TAMCA5000

Carbon (TAMCA-5000) is strong and light: six times stronger and one fifth in weight compared with iron and steel. Blades using TAMCA-5000 are light and strong with high elasticity and enable high performance.



TAMCA5000

SK7 CLASSIC

New Product

Revived Model Of The
Classic Masterpiece SK7



ATTACK	7			
SHAKE	PLY			
11.1	9.3	Regular	FL	157x150mm
REACTION	VIBRATION	BLADE	ST	157x150mm
				5.2mm
				100x25mm
				100x23mm

ZHANG JIKE SZLC

The First Model with
Super ZL-Carbon



ATTACK	5			
SHAKE	PLY			
12.3	11.1	Regular	FL	157x150mm
REACTION	VIBRATION	BLADE	AN	157x150mm
			ST	157x150mm
				5.6mm
				100x25mm
				100x24mm
				100x23mm

ZHANG JIKE T5000

Speed-Minded Model
with Carbon

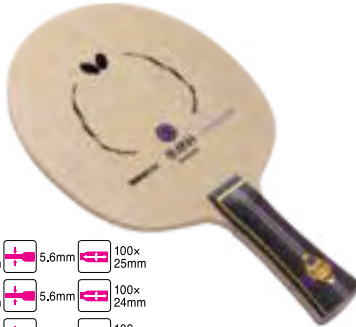

ATTACK	5			
SHAKE	PLY			
12.6	11.3	Regular	FL	157x150mm
REACTION	VIBRATION	BLADE	AN	157x150mm
			ST	157x150mm
				5.6mm
				100x25mm
				100x24mm
				100x23mm

LIU SHIWEN ZLF

Liu Shiwen's Model



ATTACK	5			
SHAKE	PLY			
9.7	8.3	Regular	FL	158x152mm
REACTION	VIBRATION	BLADE	AN	158x152mm
			ST	158x152mm
				5.6mm
				100x24mm
				100x23mm

SK CARBON

New Product

Easy-To-Use Carbon
Blade



ATTACK	3			
SHAKE	PLY			
10.5	10.5	Regular	FL	157x150mm
REACTION	VIBRATION	BLADE	ST	157x150mm
				5.2mm
				100x24mm
				100x23mm

ZHANG JIKE ZLC

Highly-Balanced
Model with ZL-Carbon

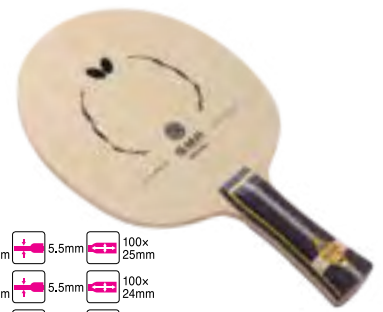

ATTACK	5			
SHAKE	PLY			
11.7	10.8	Regular	FL	157x150mm
REACTION	VIBRATION	BLADE	AN	157x150mm
			ST	157x150mm
				5.5mm
				100x25mm
				100x24mm
				100x23mm

ZHANG JIKE ALC

High Performance
Model with
Arylate-Carbon

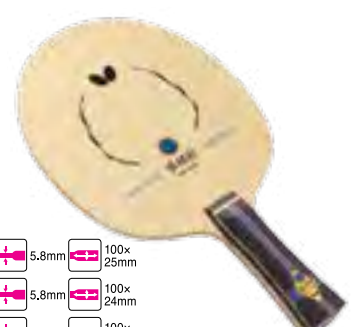

ATTACK	5			
SHAKE	PLY			
11.8	10.3	Regular	FL	157x150mm
REACTION	VIBRATION	BLADE	AN	157x150mm
			ST	157x150mm
				5.8mm
				100x25mm
				100x24mm
				100x23mm

MATSUDAIRA KENTA ALC

Kenta Matsudaira's
Model



ATTACK	5			
SHAKE	PLY			
11.8	10.3	Regular	FL	157x150mm
REACTION	VIBRATION	BLADE		5.8mm
				100x23mm

MIZUTANI JUN SZLC

Collaboration Model
with Jun Mizutani



SUPER ZLC

ATTACK SHAKE	5 PLY	AN	FL	157x 150mm	5.8mm	100x 24mm
12.5 REACTION	11.6 VIBRATION	Regular BLADE	FL	157x 150mm	5.8mm	100x 24mm
			ST	157x 150mm	5.8mm	100x 22mm

TIMO BOLL ALK

Timo Boll's Model



Arylate-CARBON

ATTACK SHAKE	5 PLY	FL	157x 150mm	5.8mm	100x 24mm
11.8 REACTION	10.3 VIBRATION	Regular BLADE	AN	157x 150mm	5.8mm
			ST	157x 150mm	5.8mm

TIMO BOLL ZLC

High Performance
Model with ZL-Carbon



ZL CARBON

ATTACK SHAKE	5 PLY	FL	157x 150mm	5.5mm	100x 24mm
11.7 REACTION	10.8 VIBRATION	Regular BLADE	AN	157x 150mm	5.5mm
			ST	157x 150mm	5.5mm

BOLL OFFENSIVE

A Step Forward



ALL-ROUND SHAKE	5 PLY	FL	158x 150mm	6.0mm	100x 25mm
10.9 REACTION	8.7 VIBRATION	Regular BLADE	AN	158x 150mm	6.0mm
			ST	158x 150mm	6.0mm

BOLL CONTROL

In Control



ALL-ROUND SHAKE	5 PLY	FL	158x 150mm	5.9mm	100x 25mm
8.6 REACTION	8.8 VIBRATION	Regular BLADE	AN	158x 150mm	5.9mm
			ST	158x 150mm	5.9mm

MIZUTANI JUN ZLC

Jun Mizutani's Model



ZL CARBON

ATTACK SHAKE	5 PLY	FL	157x 150mm	5.7mm	100x 24mm
11.8 REACTION	11.2 VIBRATION	Regular BLADE	AN	157x 150mm	5.7mm
			ST	157x 150mm	5.7mm

TIMO BOLL W7

7-Ply Blade with Power
and Control



ATTACK SHAKE	7 PLY	FL	157x 150mm	6.8mm	100x 24mm
11.4 REACTION	10.0 VIBRATION	Regular BLADE	AN	157x 150mm	6.8mm
			ST	157x 150mm	6.8mm

TIMO BOLL ZLF

High Performance
Model with ZL-Fiber



ZL FIBER

ATTACK SHAKE	5 PLY	FL	157x 150mm	5.4mm	100x 24mm
10.5 REACTION	9.4 VIBRATION	Regular BLADE	AN	157x 150mm	5.4mm
			ST	157x 150mm	5.4mm

BOLL ALLROUND

Successful Everywhere



ALL-ROUND SHAKE	5 PLY	FL	158x 150mm	5.8mm	100x 25mm
9.6 REACTION	8.3 VIBRATION	Regular BLADE	AN	158x 150mm	5.8mm
			ST	158x 150mm	5.8mm
			XXS	153x 146mm	5.5mm

BOLL FORTE

Balancing The Core



ALL-ROUND SHAKE	5 PLY	FL	158x 150mm	6.0mm	100x 25mm
11.0 REACTION	9.0 VIBRATION	Regular BLADE	AN	158x 150mm	6.0mm
			ST	158x 150mm	6.0mm

FREITAS ALC

Designed In
Collaboration With
Marcos Freitas

Arylate-CARBON

ATTACK	5	FL		157x 150mm		6.0mm		100x 25mm
SHAKE	PLY	AN		157x 150mm		6.0mm		100x 25mm
11.4	10.8	Regular	ST		157x 150mm	6.0mm		100x 23mm
REACTION	VIBRATION	BLADE						



TIMO BOLL SPIRIT

Model Which
Supported Timo Boll

Arylate-CARBON

ATTACK	5	FL		157x 150mm		5.8mm		100x 24mm
SHAKE	PLY	AN		157x 150mm		5.8mm		100x 24mm
11.8	10.3	Regular	ST		157x 150mm	5.8mm		100x 22mm
REACTION	VIBRATION	BLADE						



GARAYDIA ALC

Consistency and
Power Combined With
Arylate-Carbon

Arylate-CARBON

ATTACK	3	FL		157x 150mm		6.9mm		100x 24mm
SHAKE	PLY	AN		157x 150mm		6.9mm		100x 24mm
11.4	13.0	Regular	ST		157x 150mm	6.9mm		100x 23mm
REACTION	VIBRATION	BLADE						



INNERFORCE LAYER ZLF

High Stability Achieved
Thanks To The Thin Blade

Inner fiber
ZL FIBER

ATTACK	5	FL		157x 150mm		5.3mm		100x 24mm
SHAKE	PLY	AN		157x 150mm		5.3mm		100x 24mm
9.6	7.9	Regular	ST		157x 150mm	5.3mm		100x 22mm
REACTION	VIBRATION	BLADE						



INNERFORCE LAYER ALC

Well-Balanced Model with
Bounce and Usability

Inner fiber
Arylate-CARBON

ATTACK	5	FL		157x 150mm		6.0mm		100x 25mm
SHAKE	PLY	AN		157x 150mm		6.0mm		100x 25mm
10.7	9.4	Regular	ST		157x 150mm	6.0mm		100x 23mm
REACTION	VIBRATION	BLADE						



APOLONIA ZLC

Tiago Apolonia's
Model

Inner fiber
ZL CARBON

ATTACK	5	FL		157x 150mm		5.7mm		100x 24mm
SHAKE	PLY	AN		157x 150mm		5.7mm		100x 24mm
10.5	9.5	Regular	ST		157x 150mm	5.7mm		100x 23mm
REACTION	VIBRATION	BLADE						



GARAYDIA ZLC

Powerful High-Reaction
Model with ZL-Carbon

ZL CARBON

ATTACK	3	FL		157x 150mm		7.1mm		100x 25mm
SHAKE	PLY	AN		157x 150mm		7.1mm		100x 25mm
12.2	13.7	Regular	ST		157x 150mm	7.1mm		100x 23mm
REACTION	VIBRATION	BLADE						



GARAYDIA T5000

Speed From Carbon
Base

TAMCA 5000

ATTACK	3	FL		157x 150mm		7.2mm		100x 25mm
SHAKE	PLY	AN		157x 150mm		7.2mm		100x 25mm
13.6	14.5	Regular	ST		157x 150mm	7.2mm		100x 23mm
REACTION	VIBRATION	BLADE						



INNERFORCE LAYER ZLC

High Performance
Model Balancing
Power and Control

Inner fiber
ZL CARBON

ATTACK	5	FL		157x 150mm		5.7mm		100x 24mm
SHAKE	PLY	AN		157x 150mm		5.7mm		100x 24mm
10.5	9.5	Regular	ST		157x 150mm	5.7mm		100x 23mm
REACTION	VIBRATION	BLADE						



INNERFORCE LAYER ALC.S

Improved Ease Of Imparting
Spin On The Ball

Inner fiber
Arylate-CARBON

ATTACK	5	FL		157x 150mm		5.5mm		100x 24mm
SHAKE	PLY	AN		157x 150mm		5.5mm		100x 24mm
10.1	8.4	Regular	ST		157x 150mm	5.5mm		100x 23mm
REACTION	VIBRATION	BLADE						



KONG LINGHUI

Champion's Model
With Exquisite Control



ATTACK	5			
SHAKE	PLY			
10.6	8.4	Regular	FL	154x148mm
REACTION	VIBRATION	BLADE		5.5mm
				100x24mm

GIONIS CARBON ALLROUND

Carefully Offensive



ATTACK	5			
SHAKE	PLY			
10.2	8.0	Regular	FL	159x152mm
REACTION	VIBRATION	BLADE		5.7mm
				100x25mm
			AN	159x152mm
				5.7mm
				100x25mm
			ST	159x152mm
				5.7mm
				100x25mm

HADRAW SK

7-Ply Blade For Range
Of Styles



ATTACK	7			
SHAKE	PLY			
10.0	8.6	Regular	FL	157x150mm
REACTION	VIBRATION	BLADE		6.4mm
				100x24mm
			AN	157x150mm
				6.4mm
				100x24mm
			ST	157x150mm
				6.4mm
				100x22mm

HADRAW VK

5-Ply Blade For
All-Round Play



ATTACK	5			
SHAKE	PLY			
10.5	8.4	Regular	FL	157x150mm
REACTION	VIBRATION	BLADE		5.7mm
				100x24mm
			AN	157x150mm
				5.7mm
				100x24mm
			ST	157x150mm
				5.7mm
				100x23mm

PRIMORAC CARBON

Carbon With An
Irresistible Power



TAMCA 5000				
ATTACK	3			
SHAKE	PLY			
12.5	13.3	Regular	FL	157x150mm
REACTION	VIBRATION	BLADE		7.0mm
				100x25mm
			ST	157x150mm
				7.0mm
				100x23mm

AMULTART

High Performance
Model With ZL-Carbon



ZL CARBON				
ATTACK	3			
SHAKE	PLY			
12.2	13.7	Regular	FL	157x150mm
REACTION	VIBRATION	BLADE		7.1mm
				100x25mm
			SI	157x150mm
				7.1mm
				100x24mm

GIONIS CARBON OFFENSIVE

Straightfoward



CARBON				
ATTACK	5			
SHAKE	PLY			
11.0	8.8	Regular	FL	159x152mm
REACTION	VIBRATION	BLADE		6.2mm
				100x25mm
			AN	159x152mm
				6.2mm
				100x25mm
			ST	159x152mm
				6.2mm
				100x25mm

HADRAW SR

Powerful Attack From
High Reaction "Wenge"
Wood



ATTACK	7			
SHAKE	PLY			
10.8	9.1	Regular	FL	157x150mm
REACTION	VIBRATION	BLADE		6.6mm
				100x24mm
			AN	157x150mm
				6.6mm
				100x24mm
			ST	157x150mm
				6.6mm
				100x23mm

HADRAW VR

5-Ply All-Wood Blade
For Powerful Attack



ATTACK	5			
SHAKE	PLY			
11.4	9.3	Regular	FL	157x150mm
REACTION	VIBRATION	BLADE		5.9mm
				100x25mm
			AN	157x150mm
				5.9mm
				100x25mm
			ST	157x150mm
				5.9mm
				100x23mm

PRIMORAC

Blade With European
Speed



ATTACK	5			
SHAKE	PLY			
9.7	7.6	Regular	FL	157x150mm
REACTION	VIBRATION	BLADE		5.5mm
				100x25mm

MAZE PERFORMANCE

Distinguished
High-Level
Performance



ATTACK SHAKE	5 PLY			
10.6 REACTION	10.2 VIBRATION	Regular BLADE	FL	
			AN	
			ST	

MAZE MAGIC

A New Star



Allround SHAKE	5 PLY			
9.5 REACTION	8.5 VIBRATION	Regular BLADE	FL	
			AN	
			ST	

MAZUNOV

All Wood Blade For
Powerful Attacking



ATTACK SHAKE	5 PLY			
12.4 REACTION	10.5 VIBRATION	Regular BLADE	FL	
			AN	
			ST	

VISCARIA

Excellent Balance For
Flexibility And Bounce



ATTACK SHAKE	5 PLY			
11.8 REACTION	10.3 VIBRATION	Regular BLADE	FL	
			AN	
			ST	

SARDIUS

Carbon Blade For
Powerful Attacking



ATTACK SHAKE	3 PLY			
12.8 REACTION	14.4 VIBRATION	Regular BLADE	FL	
			AN	
			ST	

X-STAR IV

Model For Starters To
Learn The ABC's Of
Table Tennis



ALL-ROUND SHAKE	5 PLY			
10.0 REACTION	10.1 VIBRATION	Compact BLADE	FL	
			AN	
			ST	

KORBEL SK7

7-Ply Blade Popular In
Europe



ATTACK SHAKE	7 PLY			
11.1 REACTION	9.3 VIBRATION	Regular BLADE	FL	
			AN	
			ST	

KORBEL

Synonym For All-Wood
5-Ply Blade



ATTACK SHAKE	5 PLY			
10.6 REACTION	8.2 VIBRATION	Regular BLADE	FL	
			AN	
			ST	

BALSA CARBO X5

Uniting Opposites



ATTACK SHAKE	3 PLY			
8.7 REACTION	9.0 VIBRATION	Regular BLADE	FL	
			AN	
			ST	

ANDRZEJ GRUBBA

A Classic Allround Blade



ALLROUND SHAKE	5 PLY			
9.7 REACTION	7.9 VIBRATION	Regular BLADE	FL	
			AN	
			ST	

GIONIS CARBON DEFENSIVE

Precise Defense

CARBON



DEFENCE SHAKE	5 PLY	SEMI-LARGE BLADE	ST	164x 157mm	5.9mm	100x 25mm
10.1 REACTION	7.8 VIBRATION					

HADRAW SHIELD

Renowned For
Consistency In Both
Attack And Defence



DEFENCE SHAKE	5 PLY	SEMI-LARGE BLADE	FL	166x 155mm	5.3mm	100x 24mm
7.9 REACTION	6.3 VIBRATION					
			ST	166x 155mm	5.3mm	100x 23mm

INNERSHIELD LAYER ZLF

Defensive Model With
Zl-Fiber

innerfiber
ZL FIBER



DEFENCE SHAKE	5 PLY	SEMI-LARGE BLADE	FL	166x 155mm	5.1mm	100x 24mm
5.5 REACTION	4.9 VIBRATION					
			ST	166x 155mm	5.1mm	100x 23mm

JOO SAEHYUK

Collaboration Model
With Joo Saehyuk



DEFENCE SHAKE	5 PLY	SEMI-LARGE BLADE	FL	165x 156mm	6.0mm	100x 24mm
10.4 REACTION	8.5 VIBRATION					
			ST	165x 156mm	6.0mm	100x 23mm

Isotype of Butterfly Blade

Playing Style

- ATTACK SHAKE** Shakehands grip blade for powerful top spin attacking players.
- ALL-ROUND SHAKE** Shakehands grip blade for all-round players whose aim is balanced and controlled play.
- DEFENCE SHAKE** Shakehands grip blade exclusively for defensive players; less bounce enables a stable defence to be combined with a fierce attack.
- TOP SPIN MINDED PEN** Penhold grip blade for the powerful attacking top spin player.
- QUICK ATTACK PEN** Penhold grip blade suitable for attack and defence, enables fast change from forehand and backhand.
- COMBINATION PEN** Combination penhold grip blade for players with different rubber surfaces on either side of the racket.

Reaction Property

- 10.0 REACTION** The quantified reaction of blade: the higher the number, the more the reaction.

Vibration Property

- 10.0 VIBRATION** The quantified vibration frequency: the higher the number, the less vibration you feel.

Blade Size (Shakehand)



Grip Shape (Shakehand)

- FL Flared**
Gravity center is closer to grip and the blade fits in the palm.
- AN Anatomic**
Wave-shape grip fits in the palm and provides stability.
- ST Straight**
The straight grip enables player to change the way the handle is gripped according to the play.

Blade Shape (Penhold)

- S** Angular Penhold Blade
- R** Round-Angular Penhold Blade
- CS** Chinese Penhold Blade

Size

- Width and length from the forefront to grip of shakehand and Chinese penhold blade.
- Blade thickness of shakehand and Chinese penhold blade.
- Grip length and thickness of shakehand and Chinese penhold blade.
- Width and length from the forefront to grip of Japanese penhold blade.
- Blade thickness of Japanese penhold blade.
- Length and height of upper part of Japanese penhold blade.

SK CARBON CS

Easy-To-Use Carbon Blade

New Product



TAMCA5000

QUICK ATTACK PEN 3 PLY

10.5 REACTION 10.5 VIBRATION

CS 161x 150mm 5.2mm 82x 24mm

SK7 CLASSIC CS

Chinese Penhold Of All-Wood 7-Ply

New Product



QUICK ATTACK PEN 7 PLY

11.1 REACTION 9.3 VIBRATION

CS 161x 150mm 6.8mm 82x 24mm

ZHANG JIKE SZLC CS

The First Model With Super ZL-Carbon

SUPERZLC

QUICK ATTACK PEN 5 PLY

12.3 REACTION 11.1 VIBRATION

CS 161x 150mm 5.8mm 82x 24mm

AMULTART CS

High Performance Model With ZL-Carbon

ZL CARBON

QUICK ATTACK PEN 3 PLY

12.2 REACTION 13.7 VIBRATION

CS 161x 150mm 7.1mm 82x 25mm

INNERFORCE LAYER ALC CS

Well-Balanced Model With Bounce And Usability

Innerfiber ARLATE-CARBON

QUICK ATTACK PEN 5 PLY

10.7 REACTION 9.4 VIBRATION

CS 161x 150mm 6.0mm 82x 24mm



INNERFORCE LAYER ALC.S CS

Improved Ease Of Imparting Spin On The Ball

Innerfiber ARLATE-CARBON

QUICK ATTACK PEN 5 PLY

10.1 REACTION 8.4 VIBRATION

CS 161x 150mm 5.5mm 82x 24mm



INNERFORCE LAYER ZLC CS

High Performance Model Balancing Power And Control

Innerfiber ZL CARBON

QUICK ATTACK PEN 5 PLY

10.5 REACTION 9.5 VIBRATION

CS 161x 150mm 5.7mm 82x 24mm



INNERFORCE LAYER ZLF CS

High Stability Achieved Thanks To The Thin Blade

Innerfiber ZL FIBER

QUICK ATTACK PEN 5 PLY

9.6 REACTION 7.9 VIBRATION

CS 161x 150mm 5.3mm 82x 23mm



PRIMORAC CARBON CS

Carbon With An Irresistible Power

TAMCA5000

QUICK ATTACK PEN 3 PLY

12.5 REACTION 13.3 VIBRATION

CS 161x 150mm 6.9mm 82x 25mm



TIMO BOLL ALC CS

Timo Boll's Model In A CS Handle

Arylate-CARBON

QUICK ATTACK PEN 5 PLY

REACTION 11.8 VIBRATION 10.3

CS 157x150mm 5.7mm 82x24mm



TIMO BOLL ZLC CS

High Performance Model With ZL-Carbon

ZL CARBON

QUICK ATTACK PEN 5 PLY

REACTION 11.7 VIBRATION 10.8

CS 157x150mm 5.5mm 82x24mm



TIMO BOLL ZLF CS

High Performance Model With ZL-Fiber

ZL FIBER

QUICK ATTACK PEN 5 PLY

REACTION 10.5 VIBRATION 9.4

CS 157x150mm 5.4mm 82x24mm



SUPREME SPEED CS

Fast And Precise For Relentless Attacks

Arylate-CARBON

QUICK ATTACK PEN 3 PLY

REACTION 12.4 VIBRATION 14.3

CS 157x150mm 6.9mm 82x25mm



HADRAW VR CS

5-Ply Chinese Penhold For Powerful Attack

QUICK ATTACK PEN 5 PLY

REACTION 11.4 VIBRATION 9.3

CS 161x150mm 5.9mm 82x24mm



STRAVE

Strike Bravely, Strave

TAMCA 5000

QUICK ATTACK PEN 3 PLY

REACTION 11.4 VIBRATION 12.2

CS 158x150mm 6.7mm 82x23mm



CHINESE REAL

Distinguished High Speed

QUICK ATTACK PEN 5 PLY

REACTION 11.6 VIBRATION 11.0

CS 158x150mm 7.7mm 82x24mm



SHAMADA

Easy To Use Your Wrist

QUICK ATTACK PEN 5 PLY

REACTION 12.6 VIBRATION 12.6

CS 160x150mm 7.5mm 80x23mm



TAKSIM

Fast And Flexible Model With Arylate/Carbon

Arylate-CARBON

QUICK ATTACK PEN 5 PLY

REACTION 12.6 VIBRATION 11.8

CS 158x150mm 7.0mm 82x24mm



YOSHIDA KAI

Kaii Yoshida's Model

QUICK ATTACK PEN 7 PLY

REACTION 11.1 VIBRATION 9.3

CS 161x150mm 6.8mm 82x25mm



CYPRESS G-MAX

New Product

Best One-Ply
Kiso Hinoki



TOP SPIN
MINDED
PEN 1
PLY

REACTION 13.6 VIBRATION 12.9

S 163x135mm 10.0mm 92x20mm

CYPRESS T-MAX

New Product

One-Ply Kiso Hinoki
Recommended For A
Wide Range Of Players



TOP SPIN
MINDED
PEN 1
PLY

REACTION 12.4 VIBRATION 12.5

S 163x135mm 10.0mm 92x20mm

CYPRESS V-MAX

New Product

High-End One-Ply Kiso
Hinoki



TOP SPIN
MINDED
PEN 1
PLY

REACTION 13.5 VIBRATION 12.8

S 163x135mm 10.0mm 92x20mm

GARAYDIA REVOLVER

Combination Penhold
For Attack And Defense
Close To The Table



COMBI-
NATION
PEN 3
PLY

REACTION 10.5 VIBRATION 8.2

R 161x141mm 6.4mm 86x16mm

HADRAW JPV-R

Plywood Penhold Style
For All Abilities



QUICK
ATTACK
PEN 5
PLY

REACTION 11.4 VIBRATION 10.7

R 161x141mm 7.1mm 92x20mm

HADRAW JPV-S

Plywood Penhold Style
For All Abilities



TOP SPIN
MINDED
PEN 5
PLY

REACTION 11.4 VIBRATION 10.7

S 163x135mm 7.1mm 92x20mm

HADRAW REVOLVER

Easy To Use
Combination
Penhold Blade



COMBI-
NATION
PEN 5
PLY

REACTION 9.7 VIBRATION 9.0

R 161x141mm 5.9mm 86x16mm

BUTTERFLY SHAKEHAND BLADE SPECIFICATION CHART

BLADE	PLAYING STYLES	PLIES	REACTION	VIBRATION	WEIGHT (Grams) Avg.	BLADE DIMS (MM)		HEAD THICKNESS (MM)	HANDLE DIMS (MM)		
						H	W		AN	FL	SI / ST
Amultart	Attack Shake	3W+2ZLC	12.2	13.7	86	157	150	7.1	X	100x25	100x24 (SI)
Andrzej Grubba	All-Round Shake	5W	9.7	7.9	85	159	151	5.7	100x25	100x25	100x25
Apolonia ZLC	Attack Shake	5W+2ZLC	10.5	9.5	89	157	150	5.7	100x24	100x24	100x23
BalsaCarbo X5	Attack Shake	3W+2C	8.7	9.0	80	159	150	6.7	100x25	100x25	100x25
Boll Allround	All-Round Shake	5W	9.6	8.3	85	158	150	5.8	100x25	100x25	100x25
Boll Allround XXS	All-Round Shake	5W	9.6	8.3	85	153	146	5.5	X	97x22	X
Boll Control	All-Round Shake	5W	8.6	8.8	85	158	150	5.9	100x25	100x25	100x25
Boll Forte	Attack Shake	5W	11.0	9.0	90	158	150	6.0	100x25	100x25	100x25
Boll Offensive	Attack Shake	5W	10.9	8.7	90	158	150	6.0	100x25	100x25	100x25
Freitas ALC	Attack Shake	5W+2ALC	11.4	10.8	84	157	150	6.0	100x25	100x25	100x23
Garaydia ALC	Attack Shake	3W+2ALC	11.4	13.0	82	157	150	6.9	100x24	100x24	100x23
Garaydia T5000	Attack Shake	3W+2T5000	13.6	14.5	89	157	150	7.2	100x25	100x25	100x23
Garaydia ZLC	Attack Shake	3W+2ZLC	12.2	13.7	86	157	150	7.1	100x25	100x25	100x23
Gionis Carbon Allround	Attack Shake	5W+2C	10.2	8.0	85	159	152	5.7	100x25	100x25	100x25
Gionis Carbon Defensive	Defense Shake	5W+2C	10.1	7.8	85	164	157	5.9	X	X	100x25
Gionis Carbon Offensive	Attack Shake	5W+2C	11.0	8.8	90	159	152	6.2	100x25	100x25	100x25
Hadraw Shield	Defense Shake	5W	7.9	6.3	92	166	155	5.3	X	100x24	100x23
Hadraw SK	Attack Shake	7W	10.0	8.6	84	157	150	6.4	100x24	100x24	100x22
Hadraw SR	Attack Shake	7W	10.8	9.1	92	157	150	6.6	100x24	100x24	100x23
Hadraw VK	Attack Shake	5W	10.5	8.4	82	157	150	5.7	100x24	100x24	100x23
Hadraw VR	Attack Shake	5W	11.4	9.3	88	157	150	5.9	100x25	100x25	100x23
Innerforce Layer ALC	Attack Shake	5W+2ALC	10.7	9.4	85	157	150	6.0	100x25	100x25	100x23
Innerforce Layer ALC.S	Attack Shake	5W+2ALC	10.1	8.4	88	157	150	5.5	100x24	100x24	100x23
Innerforce Layer ZLC	Attack Shake	5W+2ZLC	10.5	9.5	85	157	150	5.7	100x24	100x24	100x23
Innerforce Layer ZLF	Attack Shake	5W+2ZLF	9.6	7.9	86	157	150	5.3	100x24	100x24	100x22
Innershield Layer ZLF	Defense Shake	5W+2ZLF	5.5	4.9	85	166	155	5.1	X	100x24	100x23
Joo Saehyuk	Defense Shake	5W	10.4	8.5	101	165	156	6.0	X	100x24	100x23
Kong Linghui	Attack Shake	5W	10.6	8.4	90	154	148	5.5	X	100x24	X
Korbel SK7	Attack Shake	7W	11.1	9.3	92	157	150	6.8	100x24	100x24	100x23
Liu Shiwen ZLF	Attack Shake	5W+2ZLF	9.7	8.3	86	158	152	5.6	100x24	100x24	100x23
Matsudaira Kenta ALC	Attack Shake	5W+2ALC	11.8	10.3	85	157	150	5.8	X	100x23	X
Maze Magic	All-Round Shake	5W	9.5	8.5	85	159	151	5.9	100x24	100x24	100x24
Maze Performance	Attack Shake	5W	10.6	10.2	73	157	150	6.7	X	100x24	X
Mazunov	Attack Shake	5W	12.4	10.5	102	158	152	6.7	100x25	100x25	100x23
Mizutani Jun Super ZLC	Attack Shake	5W+2SZLC	12.5	11.6	90	157	150	5.8	100x24	100x24	100x22
Mizutani Jun ZLC	Attack Shake	5W+2ZLC	11.8	11.2	85	157	150	5.7	100x24	100x24	100x22
Korbel	Attack Shake	5W	10.6	8.2	90	158	152	5.9	X	100x24	100x23
Primorac	Attack Shake	5W	9.7	7.6	84	157	150	5.5	X	100x25	X
Primorac Carbon	Attack Shake	3W+2T5000	12.5	13.3	89	157	150	7.0	X	100x25	100x23
Sardius	Attack Shake	3W+2T5000	12.8	14.4	92	158	152	7.2	X	100x25	X
SK Carbon	Attack Shake	3W+2T5000	10.5	10.5	76	157	150	5.2	X	100x24	100x23
SK7 Classic	Attack Shake	7W	11.1	9.3	90	157	150	6.8	X	100x25	100x23
Timo Boll ALC	Attack Shake	5W+2ALC	11.8	10.3	84	157	150	5.8	100x24	100x24	100x22
Timo Boll Spirit	Attack Shake	5W+2ALC	11.8	10.3	87	157	150	5.8	100x24	100x24	100x22
Timo Boll T5000	Attack Shake	5W+2T5000	12.6	11.3	90	157	150	5.6	100x24	100x24	100x22
Timo Boll W7	Attack Shake	7W	11.4	10.0	94	157	150	6.8	100x24	100x24	100x22
Timo Boll ZLC	Attack Shake	5W+2ZLC	11.7	10.8	84	157	150	5.5	100x24	100x24	100x22
Timo Boll ZLF	Attack Shake	5W+2ZLF	10.5	9.4	82	157	150	5.4	100x24	100x24	100x22
Viscaria	Attack Shake	5W+2ALC	11.8	10.3	85	157	150	5.8	X	100x25	X
X-Star IV	All-Round Shake	5W	10.0	10.1	78	154	148	6.1	X	102x24	X
Zhang Jike ALC	Attack Shake	5W+2ALC	11.8	10.3	86	157	150	5.8	102x24	100x25	100x23
Zhang Jike Super ZLC	Attack Shake	5W+2SZLC	12.3	11.1	87	157	150	5.6	102x24	100x25	100x23
Zhang Jike T5000	Attack Shake	5W+2T5000	12.6	11.3	90	157	150	5.6	102x24	100x25	100x23
Zhang Jike ZLC	Attack Shake	5W+2ZLC	11.7	10.8	86	157	150	5.5	102x24	100x25	100x23

BUTTERFLY PENHOLD SPECIFICATION CHART

BLADE	PLAYING STYLES	PLIES	REACTION	VIBRATION	WEIGHT (Grams) Avg.	BLADE DIMS (MM) H W		HEAD THICKNESS (MM)	HANDLE DIMS (MM)
CHINESE STYLE									
Amultart CS	Quick Attack Pen	3W+2ZLC	12.2	13.7	84	161	150	7.1	82x25
Chinese Real	Quick Attack Pen	5W	11.6	11.0	77	158	150	7.7	82x24
Hadraw VR CS	Quick Attack Pen	5W	11.4	9.3	85	161	150	5.9	82x24
Innerforce Layer ALC CS	Quick Attack Pen	5W+2ALC	10.7	9.4	85	161	150	6.0	82x24
Innerforce Layer ALC S CS	Quick Attack Pen	5W+2ALC	10.1	8.4	88	161	150	5.5	82x24
Innerforce Layer ZLC CS	Quick Attack Pen	5W+2ZLC	10.5	9.5	83	161	150	5.7	82x24
Innerforce Layer ZLF CS	Quick Attack Pen	5W+2ZLF	9.6	7.9	86	161	150	5.3	82x23
Primorac Carbon CS	Quick Attack Pen	3W+2T5000	12.5	13.3	84	161	150	6.9	82x25
SK Carbon CS	Quick attack Pen	3W+2T5000	10.5	10.5	76	161	150	5.2	82x24
SK7 Classic CS	Quick Attack Pen	7W	11.1	9.3	91	161	150	6.8	82x24
Shamada	Quick Attack Pen	5W	12.6	12.6	84	160	150	7.5	80x23
Strave	Quick Attack Pen	3W+2T5000	11.4	12.2	74	158	150	6.7	82x23
Supreme Speed CS	Quick Attack Pen	3W+2ALC	12.4	14.3	79	157	150	6.9	82x25
Taksim	Quick Attack Pen	5W+2ALC	12.6	11.8	80	158	150	7.0	82x24
Timo Boll ALC CS	Quick Attack Pen	5W+2ALC	11.8	10.3	84	157	150	5.7	82x24
Timo Boll ZLC CS	Quick Attack Pen	5W+2ZLC	11.7	10.8	82	157	150	5.5	82x24
Timo Boll ZLF CS	Quick Attack Pen	5W+2ZLF	10.5	9.4	81	157	150	5.4	82x24
Yoshida Kaii	Quick Attack Pen	7W	11.1	9.3	91	161	150	6.8	82x25
Zhang Jike Super ZLC CS	Quick Attack Pen	5W+2SZLC	12.3	11.1	84	161	150	5.6	82x24
JAPANESE STYLE									
Cypress G-Max	Top Spin Minded Pen	1W	13.6	12.9	93	163	135	10.0	92x20
Cypress T-Max	Top Spin Minded Pen	1W	12.4	12.5	96	163	135	10.0	92x20
Cypress V-Max	Top Spin Minded Pen	1W	12.8	13.5	94	163	135	10.0	92x20
Garaydia Revolver	Combination Pen	3W+2ALC	10.5	8.2	57	161	141	6.4	86x16
Hadraw JPV-R	Quick Attack Pen	5W	11.4	10.7	78	161	141	7.1	92x20
Hadraw JPV-S	Top Spin Minded Pen	5W	11.4	10.7	77	163	135	7.1	92x20
Hadraw Revolver	Combination Pen	5W	9.7	9.0	62	161	141	5.9	86x16

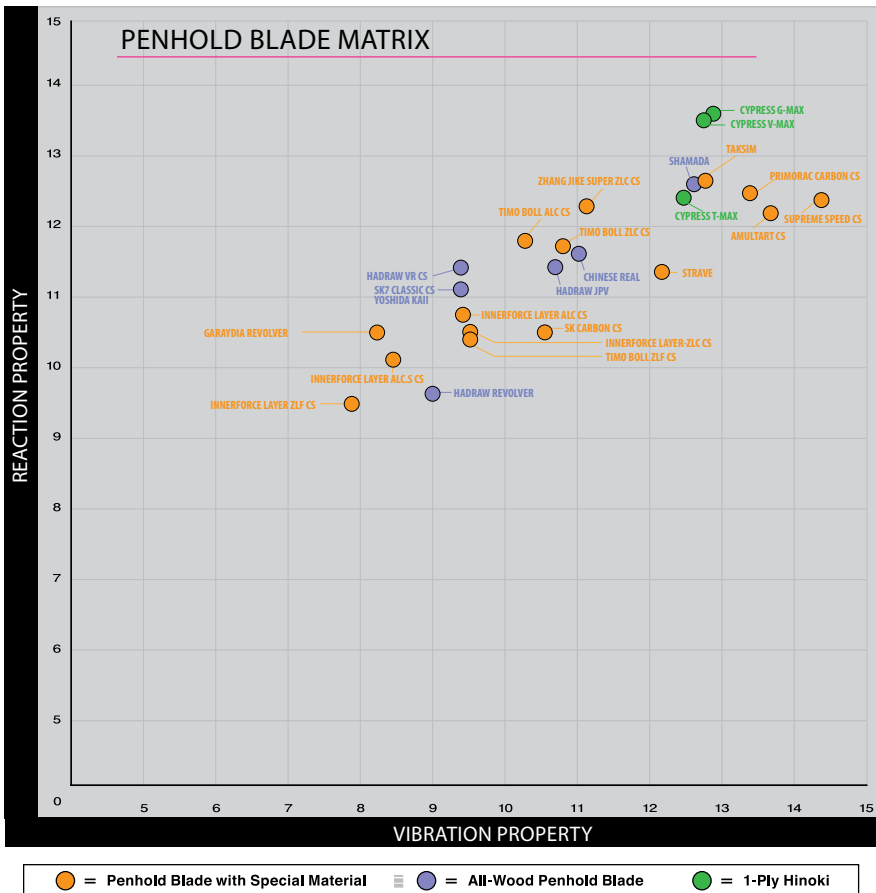

Matrix of BUTTERFLY blades comparing material REACTION and VIBRATION

REACTION PROPERTY:

The Quantified Reaction of Blade: the bigger the number, the more the reaction.



REACTION PROPERTY

10.8

VIBRATION PROPERTY:

The Quantified Vibration Frequency: the higher the number, the less vibration you feel.



VIBRATION PROPERTY

11.7

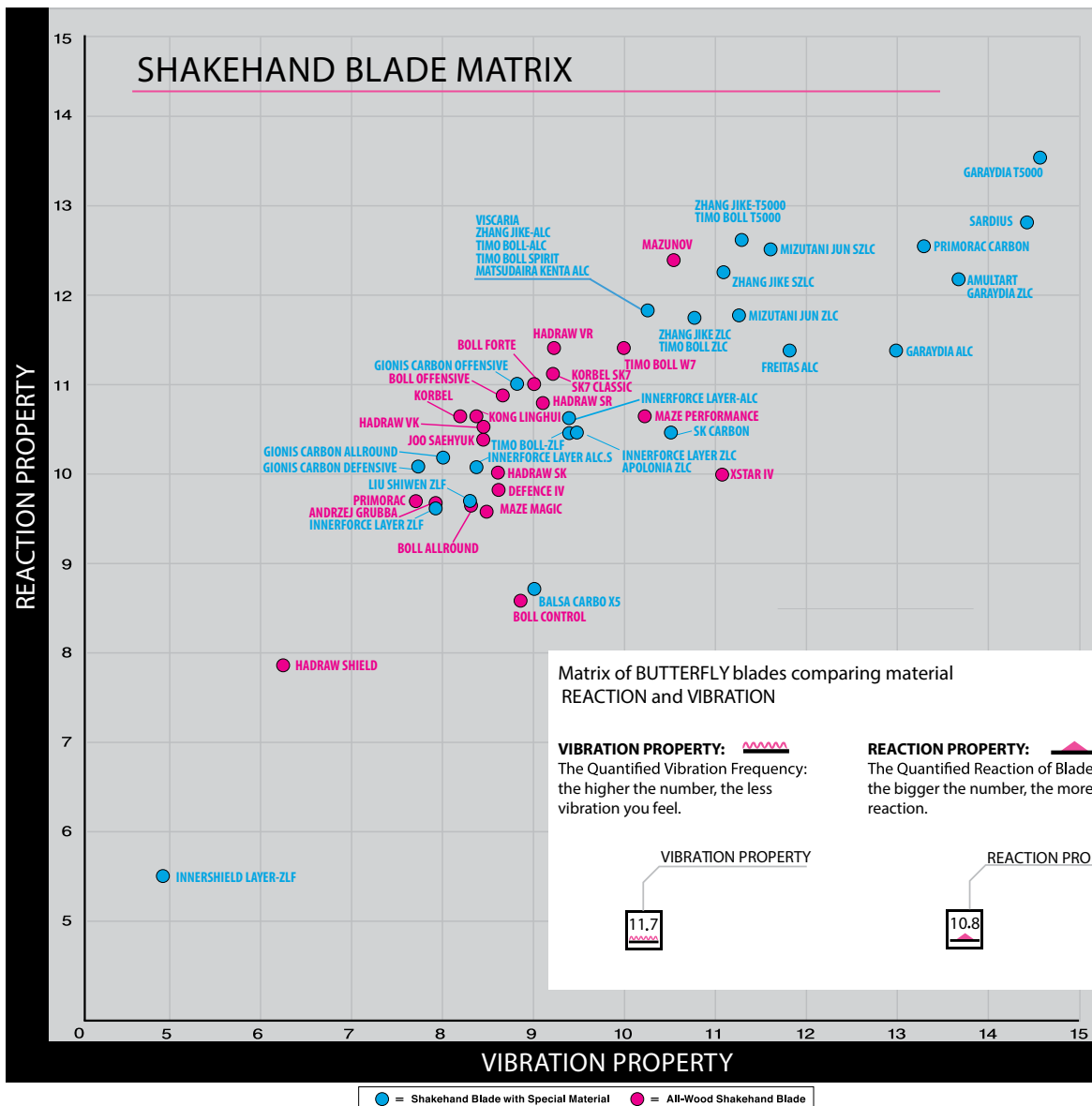

PLAYING STYLE

ATTACK SHAKE

Shakehands grip blade for power top spin attacking players.

ALL-ROUND SHAKE

Shakehands grip blade for all-round players whose aim is balanced and controlled play.

DEFENCE SHAKE

Shakehands grip blade exclusively for defensive players; less bounce enables a stable defence to be combined with a fierce attack.

QUICK ATTACK PEN

Penhold grip blade suitable for attack and defence, enables fast reaction change from forehand and backhand.

TOP SPIN MINDED PEN

Penhold grip blade for the powerful attacking top spin player.

COMBINATION PEN

Combination Penhold grip blade for players with different rubber surfaces on either side of the racket.

BLADE DIMENSIONS



Width and length from the forefront to grip of the blade

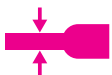

Blade thickness of the shakehand and penhold blades



Grip thickness of shakehand and penhold blade

REACTION PROPERTY



REACTION

The quantified reaction of blade: the higher the number, the more reaction

VIBRATION PROPERTY



VIBRATION

The quantified vibration frequency: the higher the number the less vibration you feel

GRIP SHAPE

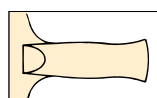

AN

Anatomic: Wave-shape grip fits the palm and provides stability

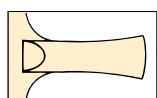

FL

Flared: Gravity center is closer to grip and the blade fits in the palm

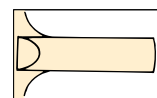

ST

Straight: The straight grip enables one to change the way of gripping according to the play

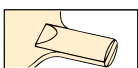

CS

Chinese Style Penhold

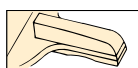

JP

Japanese Penhold

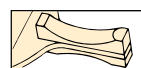

COMBINATION

Combination Penhold

HEAD SHAPE (PENHOLD)

S – Angular Penhold Blade

R – Round-Angular Penhold Blade

NAKAMA S-1 RACKET

New Product



CARBON FLEECE

Our Most Popular Rubber Of All Time And Carbon Fiber Power



1.9 Sriver



1.9 Sriver

NAKAMA S-2 RACKET

New Product



CARBON FLEECE

Carbon Power With Great Spin For Aggressive Topspin Play



1.9 Sapphira



1.9 Sapphira

NAKAMA S-3 RACKET

New Product



CARBON FLEECE

Carbon Power With Maximum Spin



1.9 Flextra



1.9 Flextra

NAKAMA S-7 RACKET

New Product



Great Spin And Better Speed For Advanced Play



1.9 Sapphira



1.9 Sapphira

NAKAMA S-8 RACKET

New Product



Great Speed And Better Spin For Advanced Play



1.9 Flextra



1.9 Flextra

NAKAMA S-9 RACKET

New Product



Good Speed And Spin With Superb Control



2.0 Pan Asia



2.0 Pan Asia

NAKAMA S-10 RACKET

New Product



Outstanding Control With Reliable Speed And Spin



2.0 Wakaba



2.0 Wakaba

NAKAMA S-4 RACKET

New Product



CARBON FLEECE

Carbon Fleece Power With Surprising Control



NAKAMA S-5 RACKET

New Product



CARBON FLEECE

Carbon Fleece Speed With High Control



NAKAMA S-6 RACKET

New Product



Tremendous Speed With Heavy Spin



NAKAMA P-1 RACKET

New Product



CARBON FLEECE

Our Most Popular Rubber Of All Time And Carbon Fleece Power



NAKAMA P-6 RACKET

New Product



Great Speed And Better Spin For Advanced Play



NAKAMA P-7 RACKET

New Product



Outstanding Control With Reliable Speed And Spin



NITCHUGO 1 RACKET

New Product



Maximum Control For The Beginning Penhold Player



ZHANG JIKE BOX SET



Racket and Case Set Named After The 2-Time World Champion

IN 2.1 Flextra **IN** 1.9 Flextra

BTY 603



Racket and Case Set Offering More Speed Than Spin

IN 2.1 Wakaba **IN** 2.1 Wakaba

BTY 501



Racket and Case Set With Balanced Speed And Spin

IN 2.1 Pan Asia **IN** 2.1 Pan Asia

BTY 401



Racket and Case Set Offering Good Speed And More Spin

IN 2.1 Yuki **IN** 2.1 Yuki

BTY 303 / 303CS



Racket and Case Set With A Combination Smooth & Pips-Out Rubber

OUT 1.9 Magnitude



IN 2.1 Yuki

BTY 302 / 302CS



Racket and Case Set Offering Good Speed And More Spin

IN 2.1 Yuki **IN** 2.1 Yuki



BTY 201



Racket and Case Set Offering Good Speed And More Spin

IN 2.0 Yuki **IN** 2.0 Yuki

BTY-CS 1000



Balanced Speed And Spin For Chinese Penhold Play

IN 2.0 Pan Asia

BTY-CS 2000



Reverse Penhold Backhand Model With Balanced Speed And Spin

IN 2.0 Pan Asia **IN** 1.5 Pan Asia

RDJ 2 PLAYER SET

New Product



Maximum Control For The Beginning Recreational Players

IN 1.5 Addoy **IN** 1.5 Addoy

RDJ 4 PLAYER SET

New Product



Control Oriented Rackets For The Whole Family

IN 1.5 Addoy **IN** 1.5 Addoy

ADDOY 1000



Maximum Control For The Beginning Recreational Player



WAKABA 1000



Outstanding Control With Reliable Speed And Spin



TIMO BOLL 1000



Good Speed And Spin With Superb Control



CARBON FLEECE

Carbon fleece layers will add more speed to a racket and it will also increase the size of the sweet-spot, making the racket more consistent.

ADDOY 2000



Maximum Control For The Beginning Recreational Player



WAKABA 2000



Outstanding Control With Reliable Speed And Spin



TIMO BOLL 2000



Good Speed And Spin With Superb Control



TIMO BOLL CF 1000



CARBON FLEECE

Carbon Fleece Speed With High Control



ADDOY 3000



Maximum Control For The Beginning Recreational Player



WAKABA 3000



Outstanding Control With Reliable Speed And Spin



TIMO BOLL 3000



Good Speed And Spin With Superb Control



TIMO BOLL CF 2000



CARBON FLEECE

Carbon Fleece Speed With High Control



ADHESIVE RUBBER PROTECT FILM III

- Protects rubber from dirt
- Tackier than rubber film
- Includes two sheets



CLEAN CARE

- Cleaning sponge in its own case
- Soft sponge is attached to the lid
- Cover easily screws closed
- Keeps your hands and bag clean



CLEAN BRUSH

- Cleaner for all pips-out rubber



COTTON SPONGE

- Thick cleaning sponge with soft cotton covering
- Perfect gentle cleaning in combination with our special cleaners



RUBBER CARE SPONGE

- Cleaning sponge for rubber
- Yellow side for regular cleaning
- Blue side for intense cleaning



RACKET CARE KIT

- A must for the serious player
- The kit includes: Butterfly foam cleaner, Rubber Care Sponge and cleaning tips
- The specially formulated cleaner will help rejuvenate the rubber surface to its natural tacky state
- The cleaning sponge offers a soft absorbent side and a very dense side that acts as a squeegee



RUBBER FILM III



- Durable plastic film designed to protect the rubber surface
- Contains two sheets

GLUE REMOVER



- For optimal removal of glue residue on blade and sponge surfaces
- Intended for use with Butterfly free chack (the Butterfly remover is not guaranteed to work on all rubbers)

CURE WATER

- Spray pump
- Non-toxic
- Non-flammable
- 150ml



SPIN REFRESH

- Environmentally friendly and non-gas type foam cleaner
- 150ml



FREE CHACK II

- Newly formulated, latex based adhesive
- Specifically designed for spring sponge rubbers, Spinart and the Tenergy series of rubbers
- Allows easy removal of excess glue from sponge and blade surface
- Stronger bond than Free Chack
- Made in Japan



20ml



100ml

FREE CHACK

- 100% Liquidized natural caoutchouc
- Easy to remove from sponge and racket
- 37ml bottle approximately 20 applications, includes 8 sponges & a clip
- 90ml bottle approximately 50 applications, includes 15 sponges & a clip
- 500ml bottle approximately 270 applications, includes 50 sponges & a clip



CHACK SHEET



- Transparent glue sheet
- 1 Sheet with two adhesive sides

RACKET SHEET



- Colored racket sheets
- Adhesive back for penhold blades
- Available in black and red

OVERGRIP SOFT TAPE

- High sensitivity material enhances the feeling of the handle
- Maximum sweat absorption and non-slip profile
- Embossed butterfly logo grip
- PU surface, elasticated micro-fiber base
- Quantity: 3 pieces



CLIP SPONGE



- The clip sponge is intended to use with Free Chack or Free Chack II
- Easily applies a thin, even layer of glue to the blade and sponge
- Each set contains 10 sponges and 1 clip

RB PROTECTOR II

- Cover edge of one racket
- Size: 10mm x 50cm



SIDE TAPE BUTTERFLY / SIDE TAPE TENERGY

- Length: 1m = 2 rackets
10m = 20 rackets
50m = 100 rackets
- Side Tape Butterfly – Colors & Sizes
 - o Black/white
 - 6mm x 10m, 6mm x 50m
 - 9mm x 1m, 9mm x 10m, 9mm x 50m
 - 12mm x 1m, 12mm x 10m, 12mm x 50m
 - o Blue/silver
 - 12mm x 10m, 12mm x 50m
- Side Tape Tenergy – Color & Sizes
 - o Orange
 - 12mm x 10m, 12mm x 50m



SOFT GRIP TAPE



- Adds comfort and thickness
- Excellent sweat absorption

POLTEH HARD CASE

New Product

Full Style Case With Durable Outer Shell

- Elastic strap secures your racket
- Mesh lining with zipper closure
- Adjustable carrying strap
- Five colors to choose from



ALU CASE



- Maximum protection for your racket and balls
- Ridged aluminum outer structure with foam inner lining
- Holds one racket and 3 balls

MELOWA DX CASE

New Product

- Center section has one large and three small mesh pouches to accommodate balls, cleaner, sponge, extra rubbers sheets, etc.
- Tray divider with handle notch for two rackets and cut-outs for four balls
- Padded front and back panels
- Made of heavy-duty nylon
- Zipper closure and carrying strap



MELOWA TOUR CASE

New Product

- Tray divider with handle notch for two rackets and cut-outs for four balls
- Accessory pouch on inside back panel
- Padded front and back panels
- Made of heavy-duty nylon
- Zipper closure



LOGO TOUR CASE



- Designed to hold two rackets and four balls
- Simple, clean design
- Padded front and back panels with an inside pouch

MELOWA FULL CASE

New Product

- Racket shaped case can accommodate a shakehand or penhold racket
- Padded front and back panels
- Made of heavy-duty nylon
- Zipper closure



MELOWA HEAD CASE

New Product

- Padded front and back panels
- Made of heavy-duty nylon
- Zipper closure



LOGO FULL CASE



- Racket shaped case with zipper closure
- Padded front and back panels

STANFLY SHOULDER BAG

New Product

- The Stanfly Shoulder bag is practical and functional.
- Perfect for your laptop, documents and other accessories.
- Bottle compartment, key hook and adjustable shoulder strap.
- One outer zipper pocket, two open pouch type and one inside zipper pocket.
- Dimensions: 30 x 40 x 19 cm



STANFLY DUFFLE BAG

New Product

- 3 outer and one inner zipper pockets
- Adjustable strap
- Dimensions: 30 x 56 x 26 cm



STANFLY TOUR BAG

New Product

- The Stanfly Tour bag is eye-catching and flexible.
- Spacious inner compartment offers plenty of room for all of your sporting needs.
- Adjustable shoulder strap.
- 3 outer pockets with zippers, 3 pouch-type pockets, and 2 inner pockets with zippers.
- Dimensions: 32 x 61 x 31 cm



STANFLY RUCKSACK

New Product

- With attention to detail, the Stanfly Rucksack provides functional mobility for a wide range of equipment.
- Its rugged construction, cleverly divided and spacious interior compartment and adjustable carrying straps make it a sporty companion for daily use.
- An outer compartment and two side pockets provide space for all kinds of small items as well as drinking bottles.
- 5 outer pockets with zipper, one inner pocket that is laptop friendly and 3 open pouch type
- Dimensions: 50 x 32 x 18 cm



MELOWA SUITCASE

New Product

Arrive In Style With The Melowa Suitcase

- The Melowa Suitcase provides a dynamic appearance everywhere.
- Features robust hard shell material, four individually suspended castors and easily converts to hand luggage.
- In the spacious interior compartment, important luggage is always ready to handle and well protected.
- Permanently installed lock protects against unwanted access and is TSA compliant.
- A coveted companion especially during air travel.
- Dimensions: 49 x 36 x 23 cm



STANFLY MAXI BAG

New Product

- The spacious Stanfly Maxi Bag is ideal for travel.
- Large main compartment offers ample storage space
- Stable chassis, telescopic handle and wet bag
- Dimensions: 80 x 39 x 39 cm



STANFLY TROLLEY

New Product

- The Stanfly Trolley is suitable for tournaments and short trips.
- Stable chassis with telescopic handle.
- Rolls effortlessly in the upright position
- In many instances the Trolley is airline, overhead bin friendly.
- Dimensions: 55 x 36 x 20 cm



TABLE FAQ

TOP

Simply put, the thicker the top, the better the bounce. A wood top that is at least 1/2" thick is suitable for home or recreational play. Many institutional tables are 5/8" to 3/4" thick. Almost all professional quality tables are a minimum of 7/8" to 1" thick.



RAIL

A heavy gauge steel rail will reinforce the structure of the table and provide additional support. It also serves a cosmetic purpose, adding to the beauty of your table.



LEGS

Heavy gauge steel legs provide a solid foundation for your table. Round legs are sufficient, but square legs are more structurally sound.



NET

All of our tables come with a net set. Our Home and Outdoor use tables offer a basic net. The Institutional and Professional level models are equipped with a higher quality cloth net which clamps directly to the table and features heavy duty brackets with padded clamps that help protect the surface of the table. These nets also offer a dual precision height adjuster.

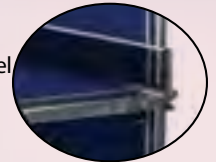

PLAYBACK POSITION

Most models allow you to fold up one half of the table and use it as a backboard. This will quicken reflexes and sharpen hand-eye coordination. A great feature for the kids.



ADJUSTABLE FEET

Many of our Institutional and Professional level tables have adjustable feet. This will ensure that the table is level, even when the floor is not.



ACCESSORY HOLDER

Some models feature a convenient accessory holder that is integrated into the frame of the table. It will accommodate multiple rackets and balls. This system also allows the net to remain attached to the table during play as well as in the storage position.



DIMENSIONS

Measure your intended playing area before ordering a table. In the play position, the table measures 9' long by 5' wide. The net brackets will add approximately 1' to the width of the table. An additional 5' on each side of the table will allow a comfortable distance for play. Storage height will vary, so be sure to check the product descriptions for more information.

It is also a good idea to measure all doorways, hallways and stairwells that the table may encounter prior to reaching its final destination.

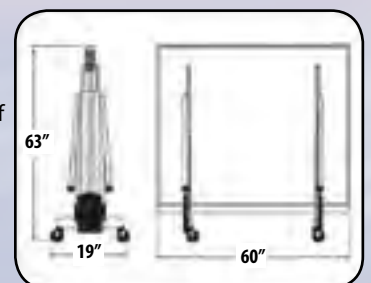

TABLE SPECIFICATIONS

YES = ✓
NO = X

Model	Top Dimensions (Inches)	Top Thickness (mm)	Top Material	Reil	Legs	Wheels	Product Weight (lbs.)	Shipping Weight (lbs.)	Playback Position	Adjustable Feet	Accessory Holder	Hassel Free Net Set (years)	Storage Dimensions H x L x W	Net Set	Assembly	Approval
Professional																
Centrefold 25	9' x 5' x 2' 6"	1"	25	Wood	2" x 3/4"	2" Square	5"	280	385	X	✓	X	63" x 60" x 19"	Europa	Fully Assembled	ITTF
Oclet 25	9' x 5' x 2' 6"	1"	25	Wood	2" x 3/4"	2" Square	4"	275	380	✓	X	X	60" x 55" x 6"	National League	30 minutes	ITTF
Europa 25	9' x 5' x 2' 6"	1"	25	Wood	2" x 3/4"	2" Square	5"	270	375	X	X	X	63" x 64" x 25"	National League	Fully Assembled	ITTF
Space Saver 22	9' x 5' x 2' 6"	7/8"	22	Wood	2" x 3/4"	1 1/2" Square	3"	215	320	X	✓	X	63" x 60" x 19"	National League	Fully Assembled	ITTF
Institutional																
Nippon 22	9' x 5' x 2' 6"	7/8"	22	Wood	2" x 3/4"	2" Square	5"	265	370	✓	X	X	73" x 60" x 30"	National League	60 minutes	USATT
Club 25	9' x 5' x 2' 6"	1"	25	Wood	1 1/2"	2 3/4" Square	4"	265	370	✓	X	✓	61" x 72" x 26"	Primus	90 minutes	USATT
Easyplay 22	9' x 5' x 2' 6"	7/8"	22	Wood	2 1/2"	1 1/2" Square	5"	209	227	✓	X	X	65" x 63" x 28"	Classic	15 minutes	USATT
Premium 19	9' x 5' x 2' 6"	3/4"	19	Wood	1 1/2" x 3/4" x 1 1/2"	1 1/2" Square	4"	205	210	✓	X	X	68" x 63" x 28"	Classic	30 minutes	USATT
Match 22	9' x 5' x 2' 6"	7/8"	22	Wood	1 1/2"	1 1/2" Square	4"	230	235	✓	X	X	68" x 63" x 28"	Classic	30 minutes	USATT
Eastfold DX 22	9' x 5' x 2' 6"	7/8"	22	MDF	1" x 1 1/2"	1 1/2" x 2 1/2"	3"	187	207	✓	X	X	64" x 63" x 25"	Match	10 minutes	USATT
Home																
Spirit 19	9' x 5' x 2' 6"	3/4"	19	MDF	1" x 1 1/2"	1 1/2" x 1 1/2"	4"	206	229	✓	X	X	64" x 67" x 26"	Clip	15 minutes	USATT
Playback 19	9' x 5' x 2' 6"	3/4"	19	Wood	1 1/2"	1" Square	5"	170	180	✓	X	✓	74" x 71" x 25"	Perfect II	90 minutes	USATT
Eastfold 19	9' x 5' x 2' 6"	3/4"	19	MDF	1 1/2" x 3/4"	1" x 1 1/2"	2 3/4"	177	205	✓	X	X	63" x 63" x 25"	Clip	10 minutes	USATT
Personal 19	9' x 5' x 2' 6"	3/4"	19	Wood	1 1/2"	1" Round	5"	170	180	✓	X	✓	74" x 71" x 25"	Perfect II	90 minutes	USATT
Compact 19	9' x 5' x 2' 6"	3/4"	19	MDF	1 1/2" x 3/4"	1 1/2" Square	2"	167	190	X	X	X	54" x 60" x 5"	Clip	Fully Assembled	USATT
Fitness 16	9' x 5' x 2' 6"	5/8"	16	MDF	1 1/2" x 3/4"	1 1/2" x 3/4"	2"	167	191	✓	X	X	61" x 63" x 21"	Economy Clip	10 minutes	USATT
Compact 16	9' x 5' x 2' 6"	5/8"	16	MDF	5/8" x 5/8"	3/4" x 3/4"	2"	132	154	X	X	X	52" x 60" x 6"	Clip	Fully Assembled	USATT
Butterfly Conversion Top	9' x 5'	5/8"	19	MDF	1 1/2" x 3/4"	N/A	N/A	110	117	X	X	X	54" x 60" x 4"	Clip	Fully Assembled	USATT
Mini																
Junior	6' 9" x 3' 9"	1/2"	12	MDF	7/8" x 5/8"	1 1/4"	2"	76	81	✓	X	X	51" x 44" x 22"	Economy Clip	10 minutes	USATT
Junior Stationary	6' 9" x 3' 9"	1/2"	12	MDF	7/8" x 5/8"	3/4" Square	2"	62	75	X	X	X	42" x 45" x 3"	Economy Clip	Fully Assembled	USATT
Starter	6' 3" x 2' 6"	1/2"	12	MDF	7/8" x 5/8"	3/4" x 3/4"	2"	51	57	X	X	X	37" x 37" x 4"	Economy Clip	Fully Assembled	USATT
Family	4' 8" x 3' 2"	1/2"	12	MDF	N/A	3/4" Round	N/A	44	49	X	X	X	28" x 45" x 3"	Fun Net	5 minutes	USATT
Indoor/Outdoor																
Compact Outdoor	9' x 5' x 2' 6"	1/2"	12	Compreg	1 1/2" x 3/4"	1 1/2" Square	2"	178	205	X	X	X	60" x 54" x 5"	Elite Outdoor	Fully Assembled	USATT
Eastfold Outdoor	9' x 5' x 2' 6"	1/2"	12	Compreg	1 1/2" x 3/4"	1" x 1 1/2"	2 3/4"	209	225	✓	X	X	63" x 63" x 25"	Elite Outdoor	10 minutes	USATT
Outdoor Playback	9' x 5' x 2' 6"	1/4"	5	SLT	1 1/2"	1" Square	5"	140	150	✓	✓	✓	74" x 71" x 25"	Perfect II	90 minutes	USATT

CENTREFOLD 25

World Class Quality; Our Flagship Model!



EUROPA 25

Perfect For A Dedicated Playing Area



OCTET 25

Great For Clubs With Limited Storage



NIPPON 22

Rock Solid With A Classic Look

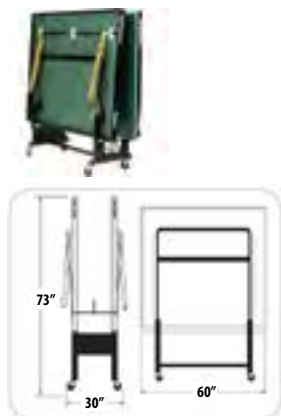

CLUB 25

Our least expensive 1" top

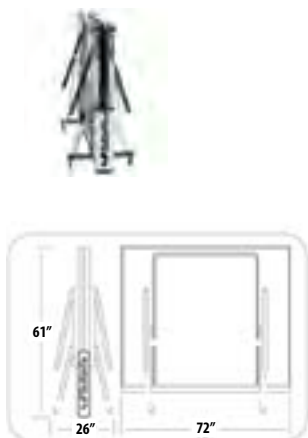

SPACE SAVER 22

Great Value With International Pedigree

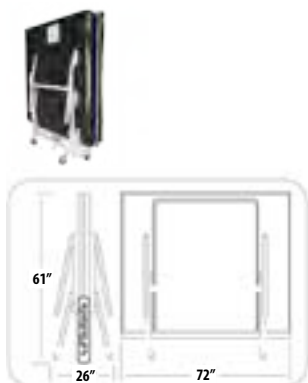

MATCH 22

Ideal For Budget-Minded Clubs

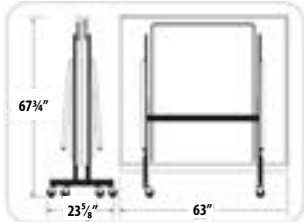

PREMIUM 19

Durable Table For Institutional Use

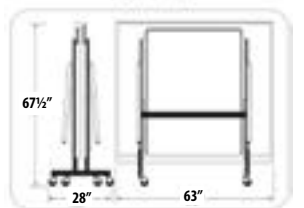

EASIFOLD 19

Quick Assembly; For Heavy Duty Home Use

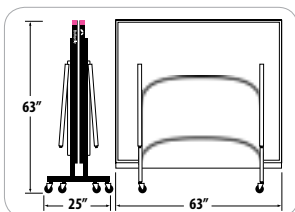

PLAYBACK 19

Our Long-Time Best Seller

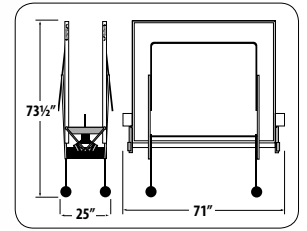

COMPACT 19

Simple, Solid And No Assembly Required

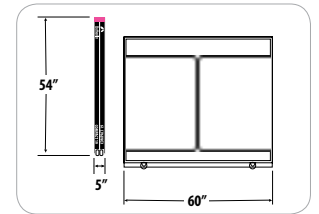

COMPACT 16 New Product

Ideal Table For Homes With Limited Storage

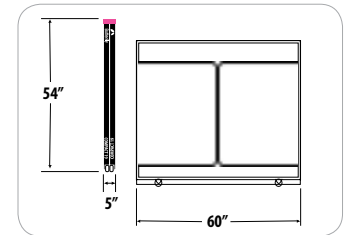

PERSONAL 19

Perfect Table For Family Game Night

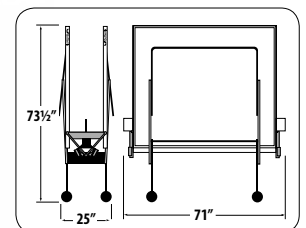

JUNIOR ROLLAWAY

New Product

Full Size Fun At Three-Fourths The Size With Wheels

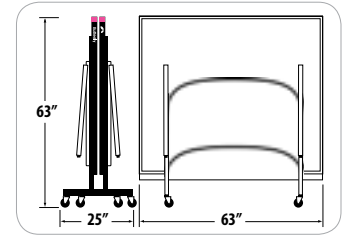

JUNIOR STATIONARY

Full Size Fun At Three-Fourths The Size

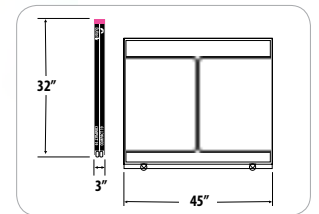

STARTER

New Product

No Space For Table Tennis, Think Again

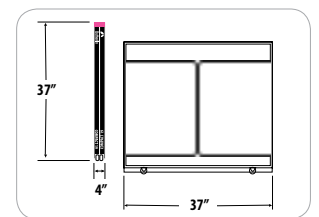

FAMILY

Great Mini Table For The Whole Family

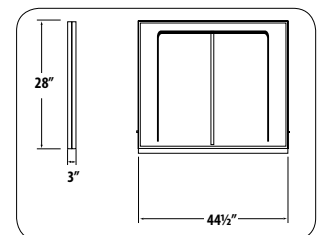

EASYPLAY 22 New Product

High-End, Quick Assembly Table

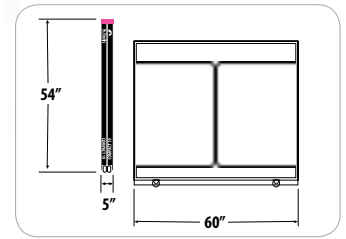

EASIFOLD DX 22 New Product

Quick Assembly With A Thicker Top

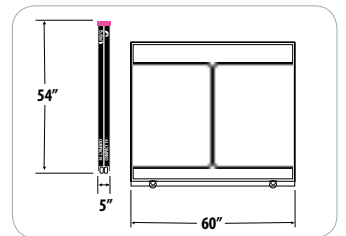

SPIRIT 19 New Product

Elegant, Sturdy Design With Accessory Holder

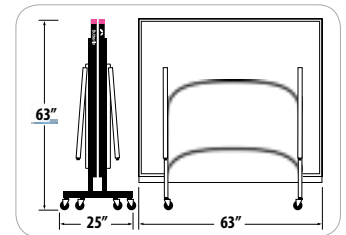

FITNESS 16 New Product

Get Your Aerobic Workout At Home

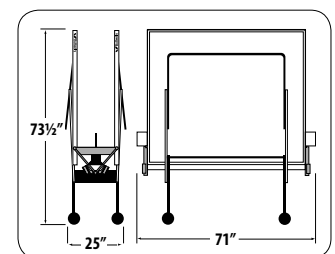

COMPACT OUTDOOR

Simple And Solid With An Excellent Outdoor Bounce

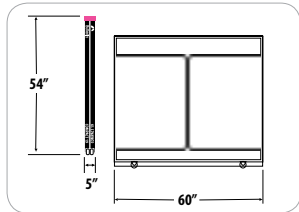

OUTDOOR PLAYBACK

Our Most Popular Outdoor Table

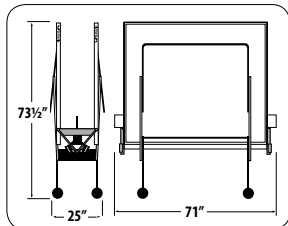

EASIFOLD OUTDOOR

Excellent Outdoor Bounce For Your Pool Or Patio

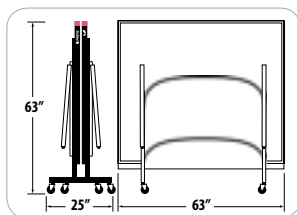

BUTTERFLY

**CENTREFOLD
25**



EUROPA 25



**EUROPA
BARRIER**



**UMPIRE
TABLE**



**TOURNAMENT
USED
TABLES**

**TOWEL &
BALL BOX**



**&
EQUIPMENT**

**LEAGUE
SCORER**



EUROPA NET SET

- Highest quality net set
- Screw on felt tipped clamps
- Ring chain to adjust net tension
- Adjustable screws to calibrate net
- Fits tables up to 1.5"



NATIONAL LEAGUE NET SET

- High quality net set
- Fits tables up to 1.75"



ELITE CLIP NET SET

- Low priced metal net set with height and tension adjustments
- Easy handling for daily use in home or club
- Black textile net



AJ NET SET New Product

- Rubber felt padded brackets and clamps
- Fits tables up to 1.75"
- Includes net height measure
- Adjustable net tension



PERFECT II NET SET

- Full replacement net set for the Personal, Playback and Outdoor Playback table models



CLUB NET SET

- Full replacement net set for the Home and Outdoor Home table models



ELITE OUTDOOR NET SET

- Replacement Net Set for Compact & Easifold Outdoor Tables



CLIP NET SET

- Replacement Net Set for Compact, Easifold & Fitness Indoor Tables



ECONOMY CLIP NET SET

- Replacement Net Set for Junior and Starter Tables



FAMILY NET

- Replacement Net for Family Table



REPLACEMENT NET & BARS

- Fits National League, & Europa Net Sets
- 72" Long



REPLACEMENT NET

- Replacement Net for National League, Europa, and Elite Clip Net Sets
- 72" Long



NET GAUGE

- Net Height Measure
- Steel
- Weight: 100g



BALL AMIGO / REPLACEMENT HEAD

- Compliment to the Ball Trainer
- Easy pick up of balls
- Adjustable, telescoping handle
- Saves your back for the matches
- Replace worn net or dented frame for Ball Amigo



BALL TRAINER

- Ball holder used for training
- Adjustable height
- Four wheels allow for easy transport



UMPIRE TABLE

- Large, flat surface for displaying scoreboard
- Great for spectator events
- Collapses flat when not in use
- Carrying handle
- Buy tournament used and save!



TABLE CLEANER

- A liquid developed using latest biological techniques
- Stainless removal of dust, dirt, and grease from the table's surface



500ml

TABLE COVER

- Protect and prolong the life of your table
- Made of durable nylon
- Zippers allow you to cover the table during storage or play positions
- Size: 60.5" x 29.5" x 59"



TOWEL & BALL BOX

- Adds a professional look to your club or game room
- Made of heavy gauge corrugated cardboard
- Can also be used for multi-ball practice
- Hexagonal shaped with Butterfly logo
- Stands 30" tall
- Buy tournament used and save!



LEAGUE SCORER

- Scoreboard stands upright inside the box top
- Includes time-out card
- Game score to 25
- Set score to 5
- Size 18.5" x 11.8" x 11.8"
- Buy tournament used and save!



DUO SCORER

- Two full size scorers in one!
- Space saving, functional & extremely stable
- Size: 15.3"X10.2"X10.2"



TOWEL & BALL BOX WOODEN

- Adds a professional look to your club or game room
- Made with a wooden storage bin and a metal base
- Can also be used for multi-ball practice
- Adjustable height



EUROPA BARRIER

Butterfly logo on one side

- Size: 7'8"x2'4"
- Buy tournament used and save!



EUROPA BARRIER DOUBLE BRACE

Butterfly logo on one side

- Size: 7'8"x2'4"



3-STAR A40+

New Product

- The new plastic Butterfly 3-Star Ball is the official ball of the 2018 World Table Tennis Championships in Halmstad, Sweden. Manufactured under strict quality control, this ball achieves high uniformity, stable rotation, speed and balance.
- Made of ABS Plastic
- Made in China
- ITTF Approved



12 CT



3 CT



6 CT

EASY BALL 40+

- Great for multi-ball practice
- Perfect for training with your Amicus robot
- Longer lasting than most plastic balls on the market
- A new production process easily creates a very round ball with an amazingly even bounce
- Very new, very round, very easy
- Made in Germany



120 CT



6 CT

3-STAR G40+

- ITTF Approved 3-Star Ball from Butterfly
- Very round as the ball has the same thickness at all points
- The bounce more closely resembles that of a celluloid ball
- New material – New feel – New sound – New ball
- Play the best, Play Butterfly
- Made in Germany



12 CT



3 CT

MASTER QUALITY 40+

- Ideal for multi-ball practice, robot training and match play
- Produced using the same guidelines as the other German-made plastic balls
- Long lasting, high-quality plastic ball
- Made in Germany



BALL BAG

New Product

- Holds more than 200 40mm balls
- Great for multi-ball training
- Material: Polyester 210 D
- Dimensions: 22.5 x 22.5 x 40cm



MELOWA BALL HOLDER

New Product

- Neatly Holds and Protects Your Balls
- Keyring Clip for Convenience



ROLLER BOX

- Can Be Used as a Hard Plastic Box for 6 Balls or as a Rolling Pin for Rubbers

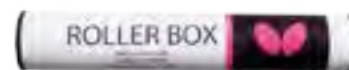

APPAREL



SHIRO SHIRT **New Product**

- Sporty and colorful design
- Breathable PK Line material with moisture absorption provides high functionality, flexibility and a comfortable wear
- Pairs well with the Apego Shorts
- Button up collar
- Material: PK Line



YASU SHIRT **New Product**

- Sweeping design and attractive colors make this shirt a real eye-catcher
- Provides high breathability and freedom of movement
- Skin-friendly and easy-care material ensures perfect fit
- Micro Dry Fit (100% polyester)



RYO T-SHIRT **New Product**

- Brightly colored t-shirt for any occasion
- Dark and light contrasting solid colors make this one fun shirt to wear
- Comfortable, relaxed fit
- Moisture wicking
- Limited Edition
- Material: Micro Dry Fit



TAKEO SHIRT **New Product**

- Classic Design And Comfortable Fit
- Material: Honeycomb Dry Fit



YASU COTTON SHIRT **New Product**

- More traditional version of the Yasu Shirt
- Blend of cotton and polyester
- Sweeping design and attractive colors make this shirt a real eye-catcher
- Cotton Mix (80% cotton / 20% polyester)



YASU LADY SHIRT **New Product**

- Sweeping design and attractive colors make this shirt a real eye-catcher
- Provides high breathability and freedom of movement
- Skin-friendly and easy-care material ensures perfect fit
- Features a tapered fit and shorter sleeves for the ladies
- Micro Dry Fit (100% polyester)



NAOMI LADY SHIRT **New Product**

- The Naomi Lady Shirt is lightweight and comfortable
- Made from Cool Dry Lycra it is flexible with a slim fit
- As a ladies shirt, it features a tapered cut and shorter sleeves
- Combines perfectly with the Chiara Skirt and Naomi Lady Tracksuit
- Material: Cool Dry Lycra (100% polyester)



BAMBOO SHIRT

- Non-Wrinkling, Anti-Static And Anti-Odorant
- Material: 81% Nano Bamboo Charcoal Polyester, 6% Nylon, 13% Spandex



USA TEAM SHIRT

- Material: Moisture Wicking Polyester (100% Polyester)



XERO SHIRT

- Material: Micro Dry Fit (100% Polyester)



TAORI SHIRT

- Material: Honey Comb Dry Fit (100% Polyester)



KIDO SHIRT

- Dry Fit Material Keeps The Skin Cool And Dry
- Material: Micro Dry Fit (100% Polyester)



KIDO LADY SHIRT

- Dry Fit Material Keeps The Skin Cool And Dry
- Material: Micro Dry Fit (100% Polyester)



TENERGY T-SHIRT

- Material: Micro Dry Fit (100% Polyester)



TENERGY LADY T-SHIRT

- Material: Micro Dry Fit (100% Polyester)



SHIRO TRACKSUIT

New Product

- The sporty, dynamic design emphasizes the diverse details and fresh color selection of the Shiro Tracksuit.
- Knitted cuffs on the sleeves and waist as well as zipper pockets on the jacket and trousers
- Long zipper pant legs allow for easy removal even when your shoes are on.
- Hooded jacket with drawstrings
- Easy-to-wear and easy-to-care functional material
- Material: Performance Micro



TAKEO TRACKSUIT

New Product

- Attractive navy and white colors combine for a comfortable and stylish suit for sport or leisure.
- Elastic waistband with drawstring pull
- Zipper pant and jacket pockets
- Long zipper on pant legs allows for easy removal
- Material: Dimple Dry Fit Elasticated - 100% polyester



YASU TRACKSUIT

New Product

- Modest with a touch of style that is comfortable and skin friendly
- Zipper pockets on both the jacket and pants
- Jacket and pants sold separately
- 3065 WR (100% polyester)



YASU LADY TRACKSUIT

New Product

- Modest with a touch of style that is comfortable and skin friendly
- A female touch to the Yasu Tracksuit
- Tapered cut to accentuate the feminine form
- Zipper pockets on both the jacket and pants
- Jacket and pants sold separately
- 3065 WR (100% polyester)



KIDO TRACKSUIT

- Material: Jaquard Stripe Mesh (100% Polyester)



KIDO LADY TRACKSUIT

- Material: Jaquard Stripe Mesh (100% Polyester)



NINYO TRACKSUIT

- Material: Laminated Fleece (100% Polyester)



NINYO LADY TRACKSUIT

- Material: Laminated Fleece (100% Polyester)



NAOKI JACKET New Product

- KPK 400 - 100% polyester
- Windproof
- Comfortable Stretch
- Skin-Friendly



SORANO WINDBREAKER New Product

- New Dobby Dry Fit - 100% polyester - UV Protection
- Skin-Friendly
- Windproof
- Water Repellent



AIRFOLG JACKET New Product

The new Airfolg Jacket from Butterfly!

- Made of Thermotron which has excellent heat storage and heat retention properties.
- The interior fill is made of Lotus Thermo which is soft and lightweight and provides superb heat retention.
- The exterior is made of Silflora which is light and strong, soft to the touch and is windproof, water repellent and is also antistatic.



ALSHEM FLEECE New Product

- Warm and cozy!
- Offers good heat retention and is antistatic



NAOMI LADY TRACKSUIT New Product

- Material: Jaquard Stripe Mesh (100% Polyester)



USA TEAM TRACKSUIT

- Material: 97% polyester and 3% Elastic
- Shell 100% Polyester



XERO TRACKSUIT

- Graphite chest with white sleeves and accented white band; black pants with white accent from hip to ankle
- Zipper pockets on both jacket and pants with Butterfly logo pull
- Butterfly logo sewn on left chest and leg
- Pants equipped with elastic waistband and drawstring as well as zippered legs
- Pants = 100% Polyester | Jacket = 100% Polyester



TAORI TRACKSUIT

- Material: Performance Micro (100% Polyester)



YASU SHORTS

- Attractive grey with a touch of style
- White accent on left hip connects with the sweeping design of the Yasu Shirt
- Elastic waistband and drawstring pull
- Zipper pockets
- Diamond Cool Dry (100% polyester)



USA TEAM SHORTS

- Material: 97% polyester and 3% Elastic



KIDO SHORTS

- Material: Stretch Polyester / Cool Dry Lycra (100% Polyester)



APEGO SHORTS

- Material: Dimple Dry Fit (100% Polyester)



PIRUS SHORTS

- Material: Plain Micro (100% Polyester)



CHI SHORTS

- Material: 100% Polyester



YASU LADY SHORTS

- Attractive grey color with a touch of style
- Inner lined and features a higher leg trim than the Yasu Shorts
- White accent on left hip connects with the sweeping design of the Yasu Shirt
- Elastic waistband and drawstring pull
- Zipper pockets
- Diamond Cool Dry (100% polyester)



CHIARA SKIRT

- Material: Cool Dry Lycra (92% Polyester, 8% Spandex)



SHIRTS | SPEC CHARTS

BAMBOO SHIRT												
		4XS	3XS	2XS	XS	S	M	L	XL	2XL	3XL	4XL
1	WIDTH	N/A	N/A	N/A	18	19.5	20	21	22	23.5	25	27
2	LENGTH	N/A	N/A	N/A	27	28.5	29.5	30.5	31	31.5	33	34

KIDO SHIRT												
		4XS	3XS	2XS	XS	S	M	L	XL	2XL	3XL	4XL
1	WIDTH	13.5	15.5	17.5	18	19	20.5	21	22	22.5	25	28
2	LENGTH	22.5	25	25	27	28.5	29.5	30.5	31	32	33.5	35.5

KIDO LADY SHIRT												
		4XS	3XS	2XS	XS	S	M	L	XL	2XL	3XL	4XL
1	WIDTH	N/A	N/A	14	15	16	17.5	18.5	19	N/A	N/A	N/A
2	LENGTH	N/A	N/A	21	22.5	24	25	26	27.5	N/A	N/A	N/A

NAOMI LADY SHIRT												
		4XS	3XS	2XS	XS	S	M	L	XL	2XL	3XL	4XL
1	WIDTH	N/A	N/A	N/A	16.5	17	18.5	18.5	20	N/A	N/A	N/A
2	LENGTH	N/A	N/A	N/A	24	24.5	25	26	27.5	N/A	N/A	N/A

RYO T-SHIRT												
		4XS	3XS	2XS	XS	S	M	L	XL	2XL	3XL	4XL
1	WIDTH	15	16	17	18	19	20.5	21	22	23	25.5	27.25
2	LENGTH	23	23.75	25	26	27.5	28.5	29	30.5	31.25	32	33.75

SHIRO SHIRT												
		4XS	3XS	2XS	XS	S	M	L	XL	2XL	3XL	4XL
1	WIDTH	13.5	15.5	16.5	18.5	19.5	20	20.75	21.5	23	25	27
2	LENGTH	21	22.25	24.25	25	26	27.75	28	28.5	30.75	31.75	32.5

TAKEO SHIRT												
		4XS	3XS	2XS	XS	S	M	L	XL	2XL	3XL	4XL
1	WIDTH	13.5	15.75	16.75	17.75	19.5	21	21.5	22.25	23.5	24.5	27
2	LENGTH	21.5	23	24.75	25.25	27	27.75	28.5	29.5	30.5	31.75	32.5

TAORI SHIRT												
		4XS	3XS	2XS	XS	S	M	L	XL	2XL	3XL	4XL
1	WIDTH	13	15.5	17	18	19	20.5	21	22	23.5	25	28
2	LENGTH	22.5	24	26.5	27	28.5	29.5	30	31	32.5	34	35

TENERGY T-SHIRT												
		4XS	3XS	2XS	XS	S	M	L	XL	2XL	3XL	4XL
1	WIDTH	13.5	16	17	18	19	20	21	22	23	25	27.5
2	LENGTH	21	23	24	25	27	28	29	30	30.5	32	33.5

TENERGY LADY T-SHIRT												
		4XS	3XS	2XS	XS	S	M	L	XL	2XL	3XL	4XL
1	WIDTH	N/A	N/A	N/A	17	18	19	21.5	22.5	N/A	N/A	N/A
2	LENGTH	N/A	N/A	N/A	23	24	25	27	27.5	N/A	N/A	N/A

YASU SHIRT												
		4XS	3XS	2XS	XS	S	M	L	XL	2XL	3XL	4XL
1	WIDTH	13.75	15.5	16.75	18.25	18.75	20.25	21.5	22.75	23.25	25.5	27
2	LENGTH	22.25	24	25.25	26.75	27	28.5	29	29.75	31	32.75	34

YASU COTTON SHIRT												
		4XS	3XS	2XS	XS	S	M	L	XL	2XL	3XL	4XL
1	WIDTH	13.25	15.75	16.5	17.5	18.5	19.5	20.75	21.75	22	24.5	26.25
2	LENGTH	21.75	23.75	25	26.25	27.5	28.5	29.25	29.75	31.5	32.75	33.75

YASU LADY SHIRT												
		4XS	3XS	2XS	XS	S	M	L	XL	2XL	3XL	4XL
1	WIDTH	N/A	N/A	N/A	15.5	17	18.5	19	21	N/A	N/A	N/A
2	LENGTH	N/A	N/A	N/A	24.5	25	27	27.5	28	N/A	N/A	N/A

USA TEAM SHIRT												
		4XS	3XS	2XS	XS	S	M	L	XL	2XL	3XL	4XL
1	WIDTH	14	15.5	16	17.5	19	20	20.5	21.5	23	25.5	27
2	LENGTH	21	23	24	25	26.5	27.5	28.5	29.25	30	31	32.75

XERO SHIRT												
		4XS	3XS	2XS	XS	S	M	L	XL	2XL	3XL	4XL
1	WIDTH	13.5	15.5	16.5	17.5	18.75	20	21	21.75	23	25	26
2	LENGTH	21	22.25	24	25.25	26	28	28.5	28.75	30.5	31	32.75

SHORTS/SKIRTS | SPEC CHARTS

APEGO SHORTS												
		4XS	3XS	2XS	XS	S	M	L	XL	2XL	3XL	4XL
1	WAIST	10.5	11.5	12	13	14	14.5	15	16	16.75	18	19
2	INSEAM	3.75	4	4.5	4.5	5	5	5.5	5.5	5.75	6.5	7
3	LENGTH	11.75	12.75	14	14.5	15.25	15.5	16	17	17.25	18.5	19
4	LEG WIDTH	10.5	11	11.5	11.75	12.25	12.5	13.25	14	14.25	14.5	14.75

CHI SHIRTS												
		4XS	3XS	2XS	XS	S	M	L	XL	2XL	3XL	4XL
1	WAIST	N/A	N/A	11.5	11.75	12.25	13.5	14	14.5	15.25	16.25	N/A
2	INSEAM	N/A	N/A	5	5.75	5.75	5.75	6.25	6.5	7	7.25	N/A
3	LENGTH	N/A	N/A	14.75	15.75	16	16.75	17.5	18	19.5	19.75	N/A
4	LEG WIDTH	N/A	N/A	11.5	11.5	12	12	13	13	13.75	14	N/A

CHIARA SKIRT												
		4XS	3XS	2XS	XS	S	M	L	XL	2XL	3XL	4XL
1	WAIST	N/A	N/A	14.5	15.5	16.5	18	18.5	19.5	20	N/A	N/A
2	LENGTH	N/A	N/A	11	11.5	11.5	12.5	13	13.5	14	N/A	N/A

KIDO SHORTS												
		4XS	3XS	2XS	XS	S	M	L	XL	2XL	3XL	4XL
1	WAIST	12.5	13	13.75	14.5	15	15.75	16.75	17.5	18.5	19.5	20
2	INSEAM	6	6.75	7	7.5	7.75	8	8.5	8.5	8.5	8.5	9
3	LENGTH	16.5	17	17.5	18.5	19	19	19.5	19.5	19.5	19.5	20
4	LEG WIDTH	9.5	9.75	10	11	11.5	11.5	12.5	12.75	13	13.5	13.5

USA TEAM SHORTS												
		4XS	3XS	2XS	XS	S	M	L	XL	2XL	3XL	4XL
1	WAIST	10.5	11.5	12	13	14	14.5	15	16	16.75	18	19
2	INSEAM	3.75	4	4.5	4.5	5	5	5.5	5.5	5.75	6.5	7
3	LENGTH	11.75	12.75	14	14.5	15.25	15.5	16	17	17.25	18.5	19
4	LEG WIDTH	10.5	11	11.5	11.75	12.25	12.5	13.25	14	14.25	14.5	14.75

YASU SHORTS												
		4XS	3XS	2XS	XS	S	M	L	XL	2XL	3XL	4XL
1	WAIST	10	11	11.5	12.25	12.75	13.75	14.25	15	16	16.5	16.75
2	INSEAM	3.75	4	4	4	4.5	4.5	5	5.5	5.5	6	6.25
3	LENGTH	11.25	12	12.5	13.5	13.75	15	15.75	16.5	17.5	18	19
4	LEG WIDTH	10.25	10.75	11	11.25	12	12.25	12.5	13.5	14	14.25	14.5

YASU LADY SHORTS												
		4XS	3XS	2XS	XS	S	M	L	XL	2XL	3XL	4XL
1	WAIST	N/A	N/A	13	14	14.5	15.25	16	17	17.5	N/A	N/A
2	INSEAM	N/A	N/A	3	3.25	3.75	4.25	4.5	4.75	5	N/A	N/A
3	LENGTH	N/A	N/A	7	8	8.5	9	10	11	11.5	N/A	N/A
4	LEG WIDTH	N/A	N/A	11.5	12	13	13.25	13.5	13.5	14.25	N/A	N/A

BUTTERFLY

CLOTHING | MATERIALS

HONEYCOMB DRY FIT

The material resembles Micro Dry Fit in composition with an even softer touch, making Honeycomb one of the most successful micro fiber in sportswear. Its comb-like structure provides better moisture transport and increased durability.



DIMPLE DRY FIT

The high quality, 100 % anti allergenic Polyester mixture provides a comfortable and skin-friendly touch. The pronounced flexibility makes Dimple Dry Fit material perfectly suited for sports and leisure. The material is quick-drying and moisture absorbent, providing comfort and protection in every season.



KPK 400

Warming, elegant and with a soft touch, KPK 400 (100 % Polyester) is a high-end sporting textile fiber and an interesting addition to the Butterfly functional fibers. KPK 400 is wind resistant, breathable and true in color and form.

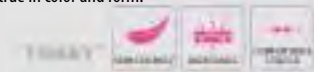

PK LINE

The special surface structure of PK LINE (100 % Polyester) combines sporting functionality with classic styling. PK Line is easy to care, elastic and provides brilliant colors.



3065 WR

A soft touch and high elasticity are the main characteristics of 3065 WR fiber. Products using 3065 WR are comfortable to wear, lightweight and breathable.



LAMINATED SOFTSHELL

With high breathability and full water and wind resistance, Laminated Softshell Fleece is equally well-suited for indoor and outdoor activities. The dense and smooth outer membrane provides high stability, a soft grip and a fine, shiny finish. Combined with the inner fleece material, Laminated Softshell Fleece features a comfortable, skin-friendly wearing sensation and elegant, sporty appearance.



MICRO DRY FIT

Micro Dry Fit is developed especially to keep the skin dry during sport. The interwoven twin-component material is made from 100 % polyester and consists of two different surface materials. The inner lining absorbs moisture and transports it towards the outer material. The outer material is breathable and flexible, making it easy to wear and soft to touch. Polyester in general is very suitable for sports activities. It's quick-drying, durable and stable in form. It's also remarkably light: 10.000 m of polyester string weighs less than 1 gram. Interesting in particular are polyester mixtures, for example combined with cotton. It unites the advantages of all materials: skin-friendly cotton, flexible elastan and moisture-absorbent polyester.



COOL DRY LYCRA

The elastic fiber is extremely flexible and adaptive, providing wrinkle-free and stable fit with increased longevity. Cool Dry Lycra is easy to care, quick-drying, bleach resistant and breathable. It is commonly used in combination with other materials to increase the overall stability and flexibility.



NEW DOBBY COATED

New Dobby Coated material protects against water and wind. Its structure enables the transfer of body moisture towards the outer layers, keeping the body comfortably dry.



PERFORMANCE MICRO

The Performance Micro material (100 % Polyester) is water-repellant, wind resistant, breathable and skin-friendly. Butterfly textiles made from Performance Micro are colour-correct, stable and easy to care.

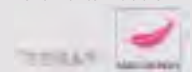

TPU DOBBY COATED

TPU Coated (100 % Polyester) is wind- and water resistant while providing an elegant appearance due to its special surface structure.



JACQUARED STRIPE MESH

The high-level polyester (100 %) uses a very attractive, elastic and durable surface structure, providing a comfortable wearing sensation and a perfect fit.



AMERICAN TERRY

Mixture between Polyester and cotton, featuring lightness and a soft and comfortable wear. The refined processing reduces environmental stress and makes the material more durable. It's highly elastic, while firm in form.



BONDED FLEECE

The twin-layered Composition of Polyester stretch with a warming inner fleece lining and a robust and flexible, yet water- and wind proof surface is suited perfectly for cold and windy days outdoors.



PLAIN MICRO

A water-resistant, wind proof and lightweight material. The fiber consists of 3 layers: an outer micro fiber, a membrane and an inner mesh lining, protecting the membrane. Butterfly Textiles made from Plain Micro Polyester are comfortable with a fresh, shiny appearance.



LEZOLINE RIFONES

New Product

- B-Armor - covering the front upper part with KPU material of high stiffness. It cushions the forefoot and protects from rapid movements
- One-Sided Shoe Tongue - connecting only the inside part of the shoe tongue, preventing undesired movements and enhances the feeling of a perfect fit
- B-Ridge - bridge-shaped middle sole supports sliding motion during footwork
- B-Absorber - special shock absorbing sponge placed between outer and middle sole of the forefoot features cushioning and flexibility
- Wingrip - specially formed outer sole has high ability of grip and assists your correct movement
- STB - prevents distortion of the shoes which happens through the particular movement of table tennis and brings you stable footwork
- Size:
 - Green (4.5-10.0)
 - Pink (4.5-10.0)
 - Navy (4.5-12.0)



LEZOLINE MACH

New Product

- High Functioning To Meet The Needs Of Top Players
- B-Absorber - special shock absorbing sponge placed between outer and middle sole of the forefoot features cushioning and flexibility
- Wingrip - specially formed outer sole has high ability of grip and assists your correct movement
- B-Ridge - bridge-shaped middle sole supports sliding motion during footwork
- STB - prevents distortion of the shoes which happens through the particular movement of table tennis and brings you stable footwork

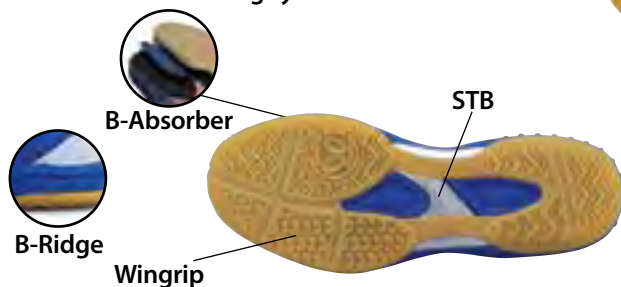

BL SHOE BAG

- Fits one pair of shoes
- Pull drawstring
- Material: PVC
- Colors: Black/Pink, Blue/Silver, Black/Green



LEZOLINE TRYNEX

- The Lezoline Trynex Shoe offers tremendous value
- Durable rubber sole offers a good grip on any playing surface
- Lightweight with great breathability due to the all mesh construction
- A well cushioned EVA insert provides added comfort
- A shoe built for a wide range of playing styles at a reasonable price
- Colors: blue or red
- Sizes: 5.0 - 10.0



LEZOLINE GROOVY

- The Groovy Shoe is smartly designed for the intense footwork of top players.
- It provides excellent grip and stabilizing properties.
- A thin midsole offers a sense of being 'barefoot', yet is surprisingly comfortable.
- The traditional mesh toe has been removed and covered, providing added durability.
- Coloring with euphoria!
- Colors: black, blue, navy (purple), pink or white
- Sizes: 4.5 - 12.0 (pink 4.5 - 8.0)



RIFONES SOCKS

- Quick drying and antibacterial
- Material: Cotton/Acrylic/Other



LEZOLINE TB

- Comfortable fit with additional stability and shock dampening
- Breathable flexible material
- Colors: Blue, Sky
- Sizes: Blue: 4.0-12.0
Sky: 4.5-11.5



SLICK SOCKS

- Quick drying and antibacterial
- Material: Cotton/Nylon



LEZOLINE ZERO

- Provides the utmost flexibility; a shoe specifically made for table tennis
- Fantastic grip and stability
- Absorbent mesh material keeps the foot dry and comfortable
- Sizes: 5.0-10.5



GROOVY SOCKS

- Quick drying and antibacterial
- Material: Cotton/Acrylic/
Polyester/Polyurethane



X-STRIPE SOCKS

- Quick drying and antibacterial
- Material: Cotton/Acrylic/
Polyester/Polyurethane



RADIAL CROSS

- Dynamic and flexible shoe that provides a firm grip on any surface
- Perfect companion for indoor and outdoor leisure activity
- Sizes: 5.5-10.0



INNERSOLES

- Provides extra cushion
- Provides secure feeling
- Sizes: S - M



FULLY
LOADED FOR
PROFESSIONAL
DEMANDS

**LEZOLINE
RIFONES**

B-Armor – KPU material with high stiffness – used in the upper part

B-Absorber – Shock absorbing sponge in the front

Wingrip – Carefully designed outer sole with high grip

B-Ridge – Bridge-shaped middle sole at the heel

STB – Prevents distortion of the shoes by table tennis specific motions

New Arrival

LEZOLINE RIFONES

Color: MAGENTA, LIME GREEN, NAVY
Size: NAVY 22.5 – 30.0 (16 sizes)
LIME GREEN, MAGENTA 22.5 – 28.0 (12 sizes)
Upper Material & Main Body: Synthetic Fiber
Reinforced Part: Synthetic Resin, Artificial Leather
Outer Sole: EVA
MADE IN CHINA

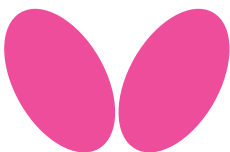

CHOICE OF THE WORLD'S BEST PLAYERS

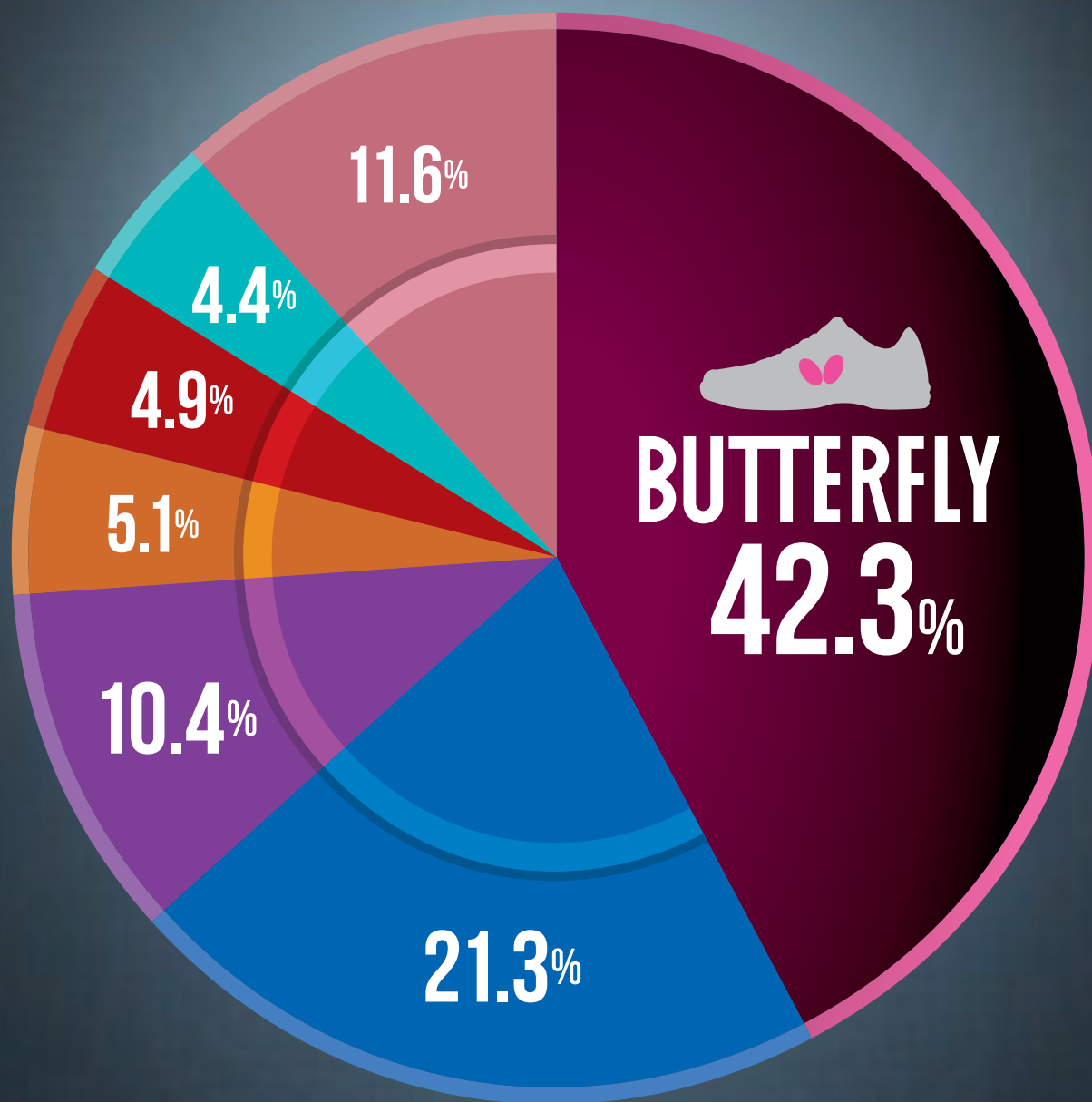

USAGE RATE OF SHOES AT WTTC 2017 IN DÜSSELDORF

*The survey of usage rate was conducted by BUTTERFLY and calculated by individual survey with players who participated in WTTC 2017 in Düsseldorf. The average valid response is 99.6%.

TABLE TENNIS FOR YOU
卓球をあなたへ

SLICK SPORTS TOWEL

- Size: 35 cm x 115 cm
- Material: 100% Cotton



SLICK HAND TOWEL

- Size: 35 cm x 35 cm
- Material: 100% Cotton



GERMANY TOWEL

- German flag design
- Size: 50 cm x 100 cm
- 100% cotton



LOGO TOWEL

- Simple and stylish design with the all new Butterfly logo
- Made of 100% Cotton
- Size: 70 cm x 140 cm



BIG LOGO TOWEL

- Size: 70 cm x 140 cm
- Material: 100% Cotton



TENERGY TOWEL

- Black with gray lettering
- Made of 100% cotton
- 100 cm x 50 cm



MINI BLADE

- Miniature wooden blade.
- Exact replica of a regular blade.
- Dimensions 6 x 3 1/2 in.



MAXI BLADE

- Enlarged wooden blade.
- Ideal for signature collecting.
- Dimensions 16 1/2 x 11 1/4 in.



MIDI BLADE

- Midi size wooden blade.
- Exact replica of a regular blade.
- Dimensions 8 1/2 x 5 in.



TENERGY KEYHOLDER

- Heavy duty keychain
- Tenergy logo on the front side
- "Butterfly Living Table Tennis" on the reverse side
- Tenergy - the 'key' to success.



KEYLACE

- Butterfly logo key lace with detachable keyring



BOTTLE OPENER

- Aluminum bottle opener keychain
- Metal split ring comes attached



NL HEADBAND

- One size fits all
- Cotton, polyester, acrylic, nylon and polyurethane

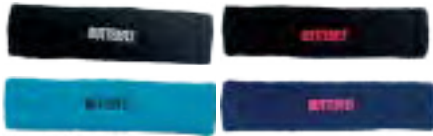

NL WRISTBAND

- One size fits all
- Cotton, polyester, acrylic, nylon and polyurethane



CAP BUTTERFLY

- Perfect for sports and leisure wear
- Modern neutral color design in grey with white logo
- One size fits all



NOTE BLOCK

- Keep tabs on all your opponents
- Non-adhesive post notes
- Each page has Butterfly wing logo



BTY MARKING PEN

- High quality magic marker
- Medium point
- Quick drying black ink
- Butterfly logo in pink and white



PEN BLACK

- Black pen with white "BUTTERFLY" printed on it, blue ink



CIRCLE KEYHOLDER

- 3cm x 3cm
- Zinc alloy



BTY WATER BOTTLE

- Clear side for accurate measurements
- Easy grip top with large hinged lid cap



TENERGY WATER BOTTLE

- Clear side for accurate measurements
- Easy grip top with large hinged lid cap



CLASSIC PIN

- Attractive lapel pin
- Butterfly logo is debossed in gold with blue background and gold trim
- Stick pin back with safety clasp closure
- 1 3/8" long x 5/16" tall



LOGO KEYHOLDER

- 2cm x 6.5 cm
- Zinc alloy



CHEER STICKS

- Make some noise!
- Cheer on your favorite player with the inflatable Cheer Sticks
- Comes with two sticks and straw to inflate
- 25" long x 4" tall.



STICKY CLEANER

- Microfiber pad for cleaning touch screens, lint and scratch free
- Adhesive reverse side for mounting on device
- Butterfly wing logo design in Magenta or White



SUPER MINI BAT

- The Super Mini Bat is a miniature version of an actual racket measuring 1.4" x 2.2"
- Comes with red and black rubber and a thin layer of sponge
- Includes clasp so it can easily be added to a keychain
- Complete with Butterfly side tape



AMICUS

TABLE TENNIS ROBOT

AMICUS

**"AN IMPORTANT
PART OF PERFECT
TRAINING
CONDITIONS."**

(RICHARD PRAUSE,
BUTTERFLY COACH)



THE AMICUS TABLE TENNIS ROBOT IS AVAILABLE IN THREE DISTINCT VARIANTS: BASIC, ADVANCE, AND PROFESSIONAL

With state-of-the-art technology and exciting features they are outstanding amongst other robots and are designed for a realistic training experience. Tailored towards amateur players as well as professionals

ADVANTAGES OF ALL MODELS:

- ▶ easy to transport, fast and simple assembly, easy to use
- ▶ lightweight (6kg)
- ▶ handy transport bag included
- ▶ up to 100 shots per minute
- ▶ unique ball eject with 3 rollers to produce topspin, backspin, sidespin and no-spin
- ▶ Speed, spin, placement and trajectory adjustable via control unit

AMICUS BASIC

EXCELLENT FOR HIGH-INTENSITY TRAINING OF STROKE TECHNIQUE AND FOOTWORK

- 6 Balls Per Exercise with Different Position
- Random Function - Balls with a Natural Scattering
- Spin, Speed and Trajectory Adjustable



AMICUS ADVANCE

IDEAL PARTNER FOR THOSE WHO WANT TO TRAIN COMPLEX PLAY SEQUENCES

- For Each Ball An Exercise Individually Adjustable: Spin + Speed + Trajectory + Placement
- Complete Ball Sequences Include Service
- Up To 10 Saved Exercises
- AFC Function (Automatic Frequency Control): For Automatic Adjustment Of The Time Intervals Between Balls With Different Speed And Spin
- Sample Function: To Play Balls Individually And Customize Their Settings with Different Speed And Spin



AMICUS PROFESSIONAL

FOR THE AMICUS PROFESSIONAL YOU DON'T HAVE TO BE A REAL PROFESSIONAL - JUST REQUIRING THE HIGHEST POSSIBLE STANDARDS IS ENOUGH

- 8 Balls Per Exercise
- 99 Exercises Saved
- Remote Control (On/Off and Speed Variation)
- IFC (Individual Frequency Control): For Individual Needs
- Cycle Function: For Automatic Game Breaks



FEATURE	AMICUS BASIC	AMICUS ADVANCE	AMICUS PROFESSIONAL
Controller	Wired Control Box	Wired Control Box	Wired Control Box (additional RF remote—has Start/ Stop, Sample, & Frequency +/- buttons)
Programmable	Up to 6 shots. Position only can be changed. Spin, speed, and height remain same.	Up to 6 shots. Adjust speed, spin type, spin amount, height, and position for each shot.	Up to 8 shots. Adjust speed, spin type, spin amount, height, timing, & position of each shot.
Sampling Button	No	Yes	Yes (also on remote)
Memory Capacity	None	Save up to 22 drills, from 1 to 6 shots each.	Save up to 99 drills, from 1 to 8 shots each.
Pre-Programmed Drills	None	10, can be modified or replaced.	20, can be modified or replaced.
Drill Sequencing	No	No	Yes (Cluster Memory)
Random Settings	Yes, 3 types—rnd, which scatters shots within a 20 cm radius of a selected point; RND, which randomly delivers a shot to 2 or more selected points; and rndRND, which combines these two random modes.	Yes, 3 types—rnd, which scatters shots within a 20 cm radius of a selected point; RND, which randomly delivers a shot to 2 or more selected points; and rndRND, which combines these two random modes.	Yes, 5 types—Place rnd, to scatter shots within a 20 cm radius of a selected point; Place RND, to randomly deliver a shot to 2 or more selected points; Place rndRND, to combine the above two random modes; Type RND, to throw balls with random speed, spin, and height; & Place/Type RND, to combine Place RND with Type RND.
Ball Frequency	11~100 Balls Per Minute	18~100 Balls Per Minute	13~120 Balls Per Minute
Frequency Customization	None	Automatic Frequency Control (AFC) provides automatic, more natural timing between shots of varying speed and spin.	Individual Frequency Control (IFC) allows you to individually adjust timing between two programmed balls.
Stopping Ball Delivery	Button press on controller.	Button press on controller.	Button press on remote or controller. Cycle pauses play every 20, 40, 60, or 80 seconds.
Spin Types	Topspin, backspin, left sidespin, right sidespin, top/left spin, top/right spin, back/left spin, back/right spin, no spin.	Topspin, backspin, left sidespin, right sidespin, top/left spin, top/right spin, back/left spin, back/right spin, no spin.	Topspin, backspin, left sidespin, right sidespin, top/left spin, top/right spin, back/left spin, back/right spin, no spin.
Spin Amount Steps	6 for topspin, 4 for backspin, sidespin has variable control knob with no discernable steps, but 4 indicators.	5 for topspin, 4 for backspin, 4 for right sidespin, 4 for left sidespin.	7 for topspin, 5 for backspin, 6 for right sidespin, 6 for left sidespin.
Speed/Spin Range	@ 50/50 to 100/0	@ 50/50 to 100/0	@ 10/90 to 100/0
How does wheel speed determine spin type & speed/spin ratio?	Speed of 3 wheels relative to each other, forward spinning only.	Speed of 3 wheels relative to each other, forward spinning only.	Speed and direction of wheels relative to each other, forward and backward spinning (Mega-Spin).
Power Supply	External wall wart with Euro & US power cords. Input: 100~240V, 50~60Hz; Output: 24V, 2.5A.	External wall wart with Euro & US power cords. Input: 100~240V, 50~60Hz; Output: 24V, 2.5A.	External wall wart with Euro & US power cords. Input: 100~240V, 50~60Hz; Output: 28V, 2.8A.
Ball Recycling Net	Yes	Yes	Yes
Carry/Storage Bag	Yes	Yes	Yes
Upgradeable	Yes, to AMICUS Advance or Professional	Yes, to AMICUS Professional	No
Manufacturer Warranty	2 years + 5 year Parts Availability Guarantee	2 years + 5 year Parts Availability Guarantee	2 years + 5 year Parts Availability Guarantee
Country of Origin	Hungary, except carry case & power supply, which are from China.	Hungary, except carry case & power supply, which are from China.	Hungary, except carry case & power supply, which are from China.

HADRAW

Philosophy of HADRAW
WENGE AS NEW

SPECIAL WOOD BLADE SERIES



W
E
N
G
E

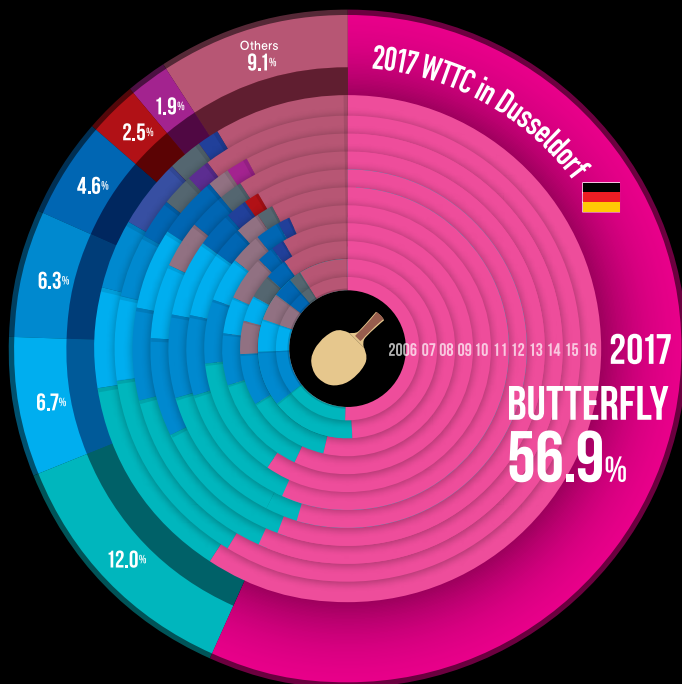

BLADES

2017 WTTC in Dusseldorf	BUTTERFLY 56.9%
2016 WTTC in Kuala Lumpur	BUTTERFLY 59.3%
2015 WTTC in Suzhou	BUTTERFLY 58.7%
2014 WTTC in Tokyo	BUTTERFLY 57.6%
2013 WTTC in Paris	BUTTERFLY 56.3%
2012 WTTC in Dortmund	BUTTERFLY 55.2%
2011 WTTC in Rotterdam	BUTTERFLY 57.0%
2010 WTTC in Moscow	BUTTERFLY 59.6%
2009 WTTC in Yokohama	BUTTERFLY 57.2%
2008 WTTC in Guangzhou	BUTTERFLY 53.1%
2007 WTTC in Zagreb	BUTTERFLY 49.2%
2006 WTTC in Bremen	BUTTERFLY 50.7%

CHOICE OF THE WORLD'S BEST PLAYERS

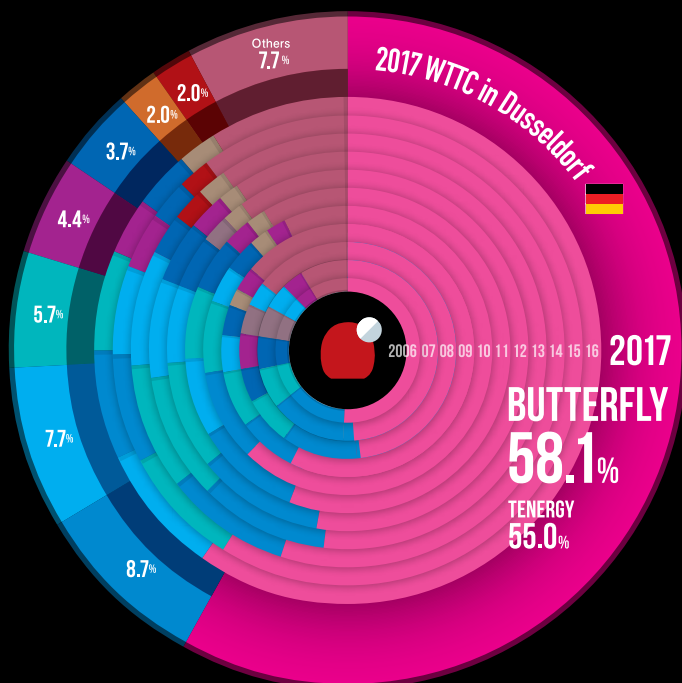

RUBBERS

2017 WTTC in Dusseldorf	BUTTERFLY 58.1%
2016 WTTC in Kuala Lumpur	BUTTERFLY 60.0%
2015 WTTC in Suzhou	BUTTERFLY 58.8%
2014 WTTC in Tokyo	BUTTERFLY 55.2%
2013 WTTC in Paris	BUTTERFLY 52.0%
2012 WTTC in Dortmund	BUTTERFLY 53.0%
2011 WTTC in Rotterdam	BUTTERFLY 55.8%
2010 WTTC in Moscow	BUTTERFLY 61.0%
2009 WTTC in Yokohama	BUTTERFLY 56.1%
2008 WTTC in Guangzhou	BUTTERFLY 47.5%
2007 WTTC in Zagreb	BUTTERFLY 48.5%
2006 WTTC in Bremen	BUTTERFLY 51.0%

*The survey was conducted by Butterfly and we investigated 99.6% of the participants at the Liebherr 2017 World Table Tennis Championships in Dusseldorf. The rubber share is calculated on the rubbers used, not the number of players present.



TABLE TENNIS FOR YOU
卓球をあなたへ



Zhang Jike



Jun Mizutani



Timo Boll



Chuang Chih-Yuan



Wong Chun Ting



Kenta Matsudaira



Maharu Yoshimura



Tomokazu Harimoto



Marcos Freitas



Tiago Apolonia



Joo Saehyuk



Kanak Jha



Cheng I-Ching



Miyu Kato



Elizabeta Samara



Yui Hamamoto



Adriana Diaz



Mo Zhang



Eugene Wang



Brian Afanador

We are Butterfly

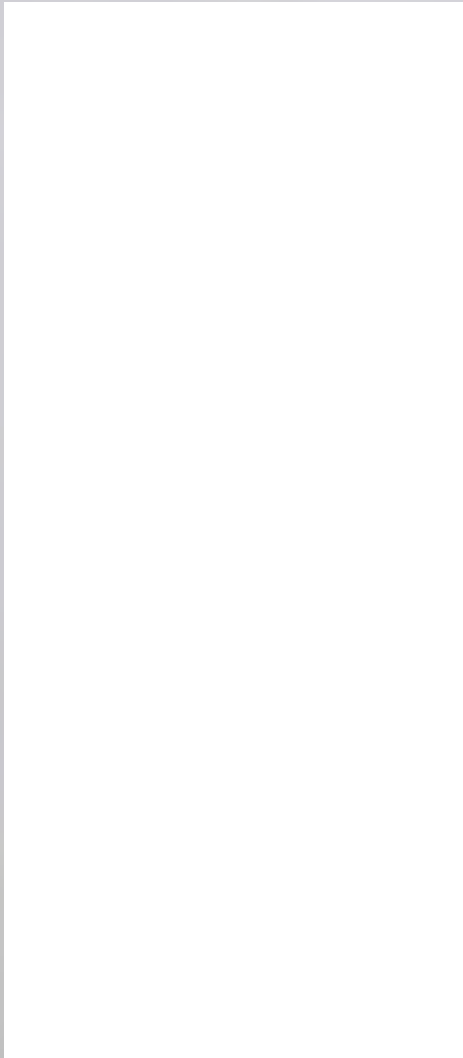

BUTTERFLY

ISSUED BY
BOWMAR SPORTS